



<http://www.ebiz-tcf.eu>

DRAFT

IMPLEMENTATION GUIDE

TRANSACTION "TEXTILE PRINTING ORDER CHANGE"

Version: draft

Date of release: 17/5/2019

Document code: G077

technical Documentation: <http://www.ebiz.enea.it>

XML Schemas repository: <http://www.ebiz.enea.it/moda-ml/repository/schema/draft/default.asp>

Guides repository: <http://www.ebiz.enea.it/moda-ml/repository/guide/draft/default.asp>

Guide filename: G077-eBIZ-TextilePrintingOrderChange.pdf

0. PREMISE

This document contains a proposal for the updating and extension of eBIZ specifications starting from the eBIZ version released as CEN CWA 16667 in 2013. Under the name of 'Draft version' it is reported the result of an extensive work of analysis and consultation aimed at developing and maintaining eBIZ specifications.

In particular, the content of this proposal is the result of various activities, mainly those carried out within the framework of the **eBIZ 4.0 project** funded by the European Commission, call COS-DESIGN-2015-3-06, topic COS-2015-DESIGN-2.

The technical contents are backwards compatible with the latest official published version.

1. BUSINESS DESCRIPTION

1.1 Scope

The present guide has been issued to assist the companies of the Textile-Clothing sector in the implementation of the standard XML document type "TEXTILE PRINTING COMMISSION ORDER CHANGE", providing all the instruction required for its use in the context of e-commerce between Printing Subcontractors and their Customers shown in the enclosed diagram

All the rules required for the construction and validation of the document are embedded into the specific XML-Schema, which is detailed in section "Implementation guide".

1.2 Generalities

The Commissioner sends to the Subcontractor a Fabric printing Order Change any time he must modify some conditions of his previous Order (eg. to suspend operations already ordered) or amend errors.

Basic function of the message is to replace an invalid Order with a valid Order, amending:

- suppliable quantities
- dates and places of delivery
- prices

The Order Change can show a number of lines different from the related Order, when variations/cancellations have occurred so as to create the splitting of an Order Line.

However the sum of the quantities of the lines in the Order Change (confirmed + varied + cancelled) must always not less than the sum of the quantities in the original Order.

When the quantity is change the original line must be splitted and the confimed amount and canceled amount should be

explicated through the 'act' flag.

1.3. Possible scenario

Subcontracted fabric printing

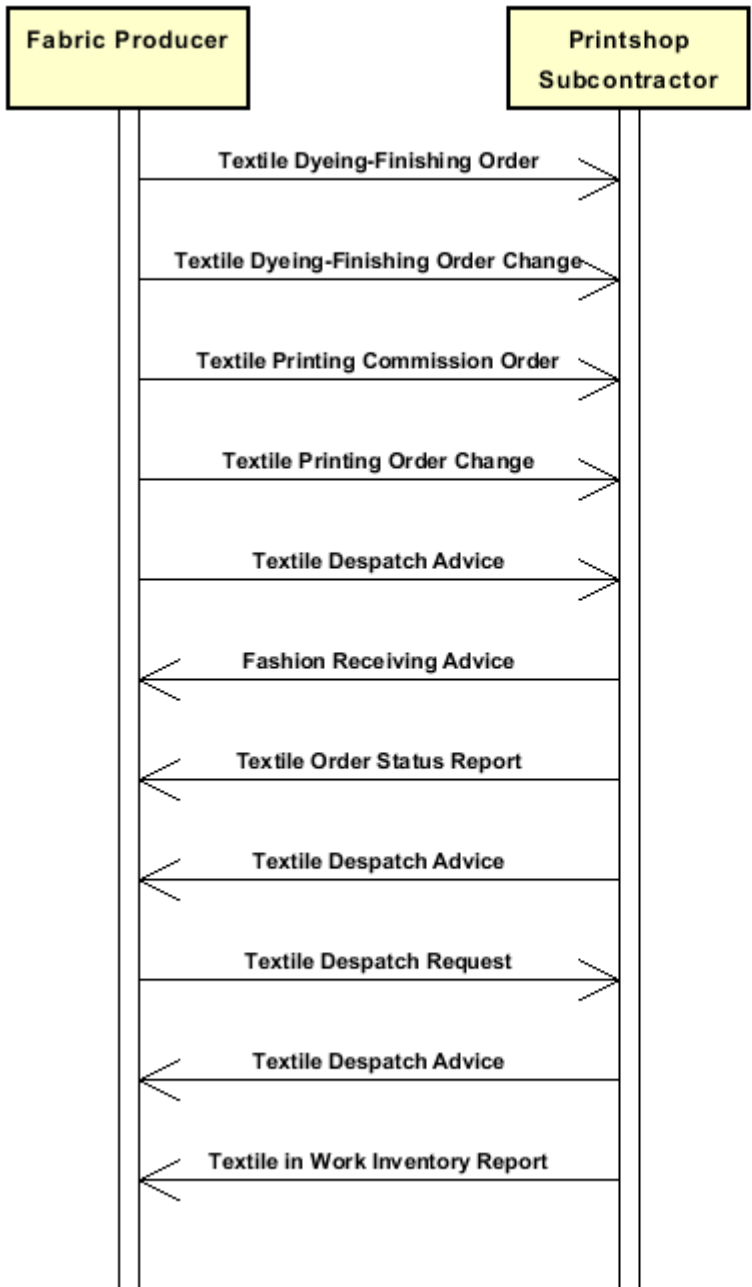

2. IMPLEMENTATION GUIDE

2.1 General structure of XML document

All the business data that can be exchanged through this class of documents are shown in the following "document structure", that provides a simplified vision of the Schema.

In particular:

- the two numbers following each element define its "cardinality" (minimum and maximum number of occurrences); the minimum equal zero indicates that the element is optional, the minimum greater than zero indicates that is mandatory;
- the bold character denotes the complex elements (aggregates of simple elements) that were built for the sake of functionality and re-usability of some complex informations sets. The child elements in each parent element are easily spotted as "indented";
- the symbol "@" denotes an attribute of the preceding element; here "the usage indicator (optional, required, ...)" is shown in square brackets.

Structure

TEXPrintOrdChange

@msgfunction [Optional]

@version [Optional] [Default= draft]

@useProfile [Optional]

| TPCXheader 1-1

| | msgN 1-1

- choose -

| | docID 0-1

| | *@numberingOrg [Optional]*

- or -

| | msgID 0-1

- end choose -

| | msgDate 1-1

| | *@dateForm [Optional]*

| | season 0-1

| | *@numberingOrg [Optional]*

| | *@codeList [Optional]*

| | *@listName [Optional]*

| | *@listVersion [Optional]*

| | msgCurrency 0-1

| refDoc 1-9

| | *@docType [Required]*

| | docID 1-2

| | *@numberingOrg [Optional]*

| | docDate 0-1

| | *@dateForm [Optional]*

| | season 0-1

| | *@numberingOrg [Optional]*

| | *@codeList [Optional]*

| | *@listName [Optional]*

| | *@listVersion [Optional]*

| | itemID 0-1

| attachment 0-1

| | *@uid [Optional]*

| | fileName 0-1

| | *@numberingOrg [Optional]*

| | binaryObject 0-1

| | *@format [Optional]*

| | *@mime [Optional]*

| | *@encoding [Optional]*

| | *@characterSet [Optional]*

```

| | | | externalReference 0-99
| | | | | uri 1-1
| | | | | @isURL [Optional] [Default= true]
| | | | | mimeTypeCode 0-1
| | | | | formatCode 0-1
| | | | | encodingCode 0-1
| | | | | characterSetCode 0-1
| | buyer 1-1
| | @logo [Optional]
| | @sender [Optional]
| | | id 1-1
| | | | @numberingOrg [Optional]
| | | additionalIdentifier 0-9
| | | | @numberingOrg [Optional]
| | | | @idQualifier [Optional]
| | | legalName 0-1
| | | dept 0-1
| | | subDept 0-1
| | | person 0-1
| | | | @email [Optional]
| | | | @phone [Optional]
| | | | @fax [Optional]
| | | street 0-1
| | | city 0-1
| | | subCountry 0-1
| | | country 0-1
| | | postCode 0-1
| | subContractor 1-1
| | @sender [Optional]
| | | id 1-1
| | | | @numberingOrg [Optional]
| | | legalName 0-1
| | | dept 0-1
| | | subDept 0-1
| | | person 0-1
| | | | @email [Optional]
| | | | @phone [Optional]
| | | | @fax [Optional]
| | | street 0-1
| | | city 0-1
| | | subCountry 0-1
| | | country 0-1
| | | postCode 0-1
| | thirdParty 0-1
| | @VAT [Optional]
| | @role [Required]
| | @sender [Optional]
| | | id 1-1
| | | | @numberingOrg [Optional]
| | | legalName 0-1
| | | dept 0-1
| | | subDept 0-1
| | | person 0-1
| | | | @email [Optional]
| | | | @phone [Optional]
| | | | @fax [Optional]
| | | street 0-1
| | | city 0-1
| | | subCountry 0-1
| | | country 0-1
| | | postCode 0-1

```

| | note 0-99
| | @numberingOrg [Optional]
| | @codeList [Optional]
| | @noteLabel [Optional]

| **terms 0-1**

| | **payment 0-5**
| | @finDiscount [Optional]
| | @finSurcharge [Optional]
| | - choose -
| | | payTerm 1-1
| | - or -
| | | payTermText 1-1
| | - end choose -
| | | payMode 0-1

| | **insPayment 0-5**
| | @part [Required]
| | - choose -
| | | payTerm 1-1
| | - or -
| | | payTermText 1-1
| | - end choose -
| | | payMode 0-1

| | **trade 0-1**
| | - choose -
| | | incoTermText 1-1
| | - or -
| | | incoTerm 1-1
| | - end choose -
| | | location 0-1
| | | @LRI [Optional]

| | **transInfo 0-5**
| | @transReason [Optional]
| | @progr [Optional]
| | | transMode 1-1
| | | carrier 0-1
| | | deliveryPlace 0-1
| | | grossWeight 0-1
| | | @um [Required]
| | | netWeight 0-1
| | | @um [Required]
| | | transMeans 0-1
| | | transCondition 0-3
| | | transConditionText 0-1
| | | despatchPlace 0-1
| | | despatchDate 0-1
| | | @dateForm [Optional]
| | | delEffectiveDate 0-1
| | | @dateForm [Optional]

| | **allowanceCharge 0-9**
| | @um [Optional]
| | @VAT [Optional]
| | @minQty [Optional]
| | @currency [Optional]
| | @maxQty [Optional]
| | - choose -
| | | AC_category 1-1
| | - or -
| | | AC_categoryText 1-1
| | - end choose -
| | - choose -

- | | | AC_percent 1-1
- | | - or -
- | | | AC_amount 1-1
- | | - end choose -
- | | | **dtScheme 0-1**
- | | | @taxType [Required]
- | | | taxCategory 0-1
- | | | taxRate 0-1
- | | | legalRef 0-1
- | | | @codeList [Required]
- | | | note 0-99
- | | | @numberingOrg [Optional]
- | | | @codeList [Optional]
- | | | @noteLabel [Optional]

TPCXbody 1-1

- | | **TPCXitem 1-unbounded**
- | | @act [Required]
- | | @productLevel [Optional] [Default= END]
- | | | lineN 1-1
- | | | @VAT [Optional]
- | | | **refDoc 1-9**
- | | | @docType [Required]
- | | | docID 1-2
- | | | @numberingOrg [Optional]
- | | | docDate 0-1
- | | | @dateForm [Optional]
- | | | season 0-1
- | | | @numberingOrg [Optional]
- | | | @codeList [Optional]
- | | | @listName [Optional]
- | | | @listVersion [Optional]
- | | | itemID 0-1
- | | | **attachment 0-1**
- | | | @uid [Optional]
- | | | | fileName 0-1
- | | | | @numberingOrg [Optional]
- | | | | binaryObject 0-1
- | | | | @format [Optional]
- | | | | @mime [Optional]
- | | | | @encoding [Optional]
- | | | | @characterSet [Optional]
- | | | | **externalReference 0-99**
- | | | | uri 1-1
- | | | | @isURL [Optional] [Default= true]
- | | | | mimeTypeCode 0-1
- | | | | formatCode 0-1
- | | | | encodingCode 0-1
- | | | | characterSetCode 0-1
- | | | **fabricProd 0-1**
- | | | @CTest [Optional]
- | | | | **texCode 1-1**
- | | | | @numberingOrg [Optional]
- | | | | art 1-1
- | | | | @numberingOrg [Optional]
- | | | | @codeList [Optional]
- | | | | @listName [Optional]
- | | | | @listVersion [Optional]
- | | | | pattern 0-1
- | | | | @numberingOrg [Optional]
- | | | | @codeList [Optional]

```

| | | | @listName [Optional]
| | | | @listVersion [Optional]
| | | | color 0-1
| | | | @numberingOrg [Optional]
| | | | @codeList [Optional]
| | | | @listName [Optional]
| | | | @listVersion [Optional]
| | | | added 0-9
| | | | @numberingOrg [Optional]
| | | | @addType [Optional]
| | | | description 0-unbounded
| | | | @ln [Optional]
| | | | fabricCompos 0-1
| | | | | percCompos 1-9
| | | | | @fibre [Required]
| | | | fabricWidth 0-1
| | | | | @um [Optional] [Default= CMT]
| | | | fabricSpecs 0-99
| | | | - choose -
| | | | | fabricCharText 1-1
| | | | - or -
| | | | | fabricChar 1-1
| | | | - end choose -
| | | | | specValue 0-1
| | | | | | @um [Optional]
| | | | | | @source [Optional]
| | | | | | @method [Optional]
| | | | | | @application [Optional]
| | | | | | @CV [Optional]
| | | | - choose -
| | | | | tolerance 0-2
| | | | | | @um [Required]
| | | | - or -
| | | | | pcTolerance 0-2
| | | | | | @um [Optional]
| | | | - end choose -
| | | | - choose -
| | | | | pieceChain 0-99
| | | | | serialN 1-9
| | | | | | @numberingOrg [Optional]
| | | | | | @idQualifier [Optional]
| | | | | pieceLength 0-1
| | | | | | @um [Optional] [Default= MTR]
| | | | | pieceWidth 0-1
| | | | | | @um [Optional] [Default= CMT]
| | | | | pieceWeight 0-1
| | | | | | @um [Optional] [Default= KGM]
| | | | | lotN 0-1
| | | | | | @numberingOrg [Optional]
| | | | | dyeN 0-1
| | | | | | @numberingOrg [Optional]
| | | | | packageN 0-1
| | | | | | @numberingOrg [Optional]
| | | | | | @packageContainerN [Optional]
| | | | | piecePack 0-1
| | | | | - choose -
| | | | | | piecePackText 1-1
| | | | | - or -
| | | | | | pieceInnWrap1 1-1
| | | | | | pieceInnWrap2 0-1
| | | | | | pieceOutWrap 0-1

```



```

- end choose -
| | | | | pieceCut 0-99
| | | | | serialN 1-9
| | | | | @numberingOrg [Optional]
| | | | | @idQualifier [Optional]
| | | | | pieceLength 0-1
| | | | | @um [Optional] [Default= MTR]
| | | | | pieceWeight 0-1
| | | | | @um [Optional] [Default= KGM]
- or -
| | | | | piece 0-99
| | | | | @endUse [Optional]
| | | | | serialN 0-9
| | | | | @numberingOrg [Optional]
| | | | | @idQualifier [Optional]
| | | | | EPC 0-1
| | | | | @numberingOrg [Optional]
| | | | | @TID [Optional]
| | | | | totFault 0-1
| | | | | pieceStatus 0-1
| | | | | pieceLength 0-1
| | | | | @um [Optional] [Default= MTR]
| | | | | pieceWidth 0-1
| | | | | @um [Optional] [Default= CMT]
| | | | | pieceCutWidth 0-1
| | | | | @um [Optional] [Default= CMT]
| | | | | pieceWeight 0-1
| | | | | @um [Optional] [Default= KGM]
| | | | | pieceWeightM 0-1
| | | | | @um [Optional] [Default= GRM]
| | | | | grossWeight 0-1
| | | | | @um [Required]
| | | | | pieceAllow 0-1
| | | | | @um [Required]
| | | | | lotN 0-2
| | | | | @numberingOrg [Optional]
| | | | | dyeN 0-1
| | | | | @numberingOrg [Optional]
| | | | | mixMatch 0-1
| | | | | @numberingOrg [Optional]
| | | | | packageN 0-1
| | | | | @numberingOrg [Optional]
| | | | | @packageContainerN [Optional]
| | | | | piecePack 0-1
- choose -
| | | | | piecePackText 1-1
- or -
| | | | | pieceInnWrap1 1-1
| | | | | pieceInnWrap2 0-1
| | | | | pieceOutWrap 0-1
- end choose -
- end choose -
| | | | | note 0-99
| | | | | @numberingOrg [Optional]
| | | | | @codeList [Optional]
| | | | | @noteLabel [Optional]
| | | | | qty 0-3
| | | | | @um [Required]
| | | | | price 0-1
| | | | | @um [Optional]
| | | | | @priceQualifier [Optional] [Default= NET]

```

```

| | | @currency [Optional]
| | | deliveryDate 0-1
| | | @dateForm [Optional]
| | | thirdParty 0-1
| | | @VAT [Optional]
| | | @role [Required]
| | | @sender [Optional]
| | | | id 1-1
| | | | | @numberingOrg [Optional]
| | | | legalName 0-1
| | | | dept 0-1
| | | | subDept 0-1
| | | | person 0-1
| | | | | @email [Optional]
| | | | | @phone [Optional]
| | | | | @fax [Optional]
| | | | street 0-1
| | | | city 0-1
| | | | subCountry 0-1
| | | | country 0-1
| | | | postCode 0-1
| | | fabricComponent 0-9
| | | | texCode 1-1
| | | | | @numberingOrg [Optional]
| | | | | | art 1-1
| | | | | | | @numberingOrg [Optional]
| | | | | | | @codeList [Optional]
| | | | | | | @listName [Optional]
| | | | | | | @listVersion [Optional]
| | | | | | pattern 0-1
| | | | | | | @numberingOrg [Optional]
| | | | | | | @codeList [Optional]
| | | | | | | @listName [Optional]
| | | | | | | @listVersion [Optional]
| | | | | | color 0-1
| | | | | | | @numberingOrg [Optional]
| | | | | | | @codeList [Optional]
| | | | | | | @listName [Optional]
| | | | | | | @listVersion [Optional]
| | | | | | added 0-9
| | | | | | | @numberingOrg [Optional]
| | | | | | | @addType [Optional]
| | | | | | description 0-unbounded
| | | | | | | @ln [Optional]
| | | | qty 1-3
| | | | | @um [Required]
| | | - choose -
| | | | serialN 0-unbounded
| | | | | @numberingOrg [Optional]
| | | | | @idQualifier [Optional]
| | | - or -
| | | | itemsList 0-unbounded
| | | | | qualityLevel 0-1
| | | | | | @numberingOrg [Optional]
| | | | | | @codeList [Optional]
| | | | | | @listName [Optional]
| | | | | | @listVersion [Optional]
| | | | | itemIdentification 1-unbounded
| | | | | | serialN 1-9
| | | | | | | @numberingOrg [Optional]
| | | | | | | @idQualifier [Optional]

```

- end choose -

refDoc 0-1

| @docType [Required]
| docID 1-2
| | @numberingOrg [Optional]
| docDate 0-1
| | @dateForm [Optional]
| season 0-1
| | @numberingOrg [Optional]
| | @codeList [Optional]
| | @listName [Optional]
| | @listVersion [Optional]
| itemID 0-1

attachment 0-1

| @uid [Optional]
| | fileName 0-1
| | | @numberingOrg [Optional]
| | binaryObject 0-1
| | | @format [Optional]
| | | @mime [Optional]
| | | @encoding [Optional]
| | | @characterSet [Optional]
| | **externalReference 0-99**
| | | uri 1-1
| | | | @isURL [Optional] [Default= true]
| | | | mimeTypeCode 0-1
| | | | formatCode 0-1
| | | | encodingCode 0-1
| | | | characterSetCode 0-1

| location 0-1
| | @LRI [Optional]
| note 0-99
| | @numberingOrg [Optional]
| | @codeList [Optional]
| | @noteLabel [Optional]

fabPrintOperation 0-9

| fabPrintTech 1-1
| dyeStuff 0-1

fabPrintSpecs 0-9

- choose -

| | fabPrintCharText 1-1

- or -

| | fabPrintChar 1-1

- end choose -

| specValue 0-1
| | @um [Optional]
| | @source [Optional]
| | @method [Optional]
| | @application [Optional]
| | @CV [Optional]

| groundColor 0-9
| | @numberingOrg [Optional]
| | @screenN [Required]

refDoc 0-1

| @docType [Required]
| docID 1-2
| | @numberingOrg [Optional]
| docDate 0-1
| | @dateForm [Optional]
| season 0-1
| | @numberingOrg [Optional]

```

| | | | @codeList [Optional]
| | | | @listName [Optional]
| | | | @listVersion [Optional]
| | | | itemID 0-1
| | | | attachment 0-1
| | | | @uid [Optional]
| | | | | fileName 0-1
| | | | | @numberingOrg [Optional]
| | | | | binaryObject 0-1
| | | | | @format [Optional]
| | | | | @mime [Optional]
| | | | | @encoding [Optional]
| | | | | @characterSet [Optional]
| | | | | externalReference 0-99
| | | | | | uri 1-1
| | | | | | | @isURL [Optional] [Default= true]
| | | | | | mimeCode 0-1
| | | | | | formatCode 0-1
| | | | | | encodingCode 0-1
| | | | | | characterSetCode 0-1
| | | | note 0-99
| | | | | @numberingOrg [Optional]
| | | | | @codeList [Optional]
| | | | | @noteLabel [Optional]
| | | | dtScheme 0-1
| | | | | @taxType [Required]
| | | | | taxCategory 0-1
| | | | | taxRate 0-1
| | | | | legalRef 0-1
| | | | | @codeList [Required]
| | | | | note 0-99
| | | | | | @numberingOrg [Optional]
| | | | | | @codeList [Optional]
| | | | | | @noteLabel [Optional]

```

2.2 Detailed description of document elements

Following tables show all elements (complex and simple) used in this document. Description includes: 1) element's information: xml tag, name, brief description, data type and syntax constraints; 2) information about use of the element in a particular position in the document: xpath and possible associated notes.

2.2.1 Complex elements (Aggregate Business Information Entities)

Complex elements are those elements whose content is composed of other elements (childs).Complex elements are alphabetically ordered.

allowanceCharge	Allowances and Charges related to an Order or a contract (XPath <code>TEXPrintOrdChange/terms/allowanceCharge</code>) 0-9
attachment	an attached document. An attachment can refer to an external document or be included with the document being exchanged (XPath <code>TEXPrintOrdChange/TPCXheader/refDoc/attachment</code>) 0-1 (XPath <code>TEXPrintOrdChange/TPCXbody/TPCXitem/fabricComponent/refDoc/attachment</code>) 0-1 (XPath <code>TEXPrintOrdChange/TPCXbody/TPCXitem/fabPrintOperation/refDoc/attachment</code>) 0-1 (XPath <code>TEXPrintOrdChange/TPCXbody/TPCXitem/refDoc/attachment</code>) 0-1
buyer	details of the Buyer (party that buys the good or service that is object of the current collaborative process) - base type: Nad, (XPath <code>TEXPrintOrdChange/TPCXheader/buyer</code>) 1-1
dtScheme	set of data usable to declare the duty or tax applied (XPath <code>TEXPrintOrdChange/TPCXbody/TPCXitem/dtScheme</code>) 0-1 (XPath <code>TEXPrintOrdChange/terms/allowanceCharge/dtScheme</code>) 0-1
externalReference	details about an external object, such as a document stored at a remote location (XPath <code>TEXPrintOrdChange/TPCXbody/TPCXitem/fabPrintOperation/refDoc/attachment/externalReference</code>) 0-99 (XPath <code>TEXPrintOrdChange/TPCXbody/TPCXitem/refDoc/attachment/externalReference</code>) 0-99 (XPath <code>TEXPrintOrdChange/TPCXbody/TPCXitem/fabricComponent/refDoc/attachment/externalReference</code>) 0-99 (XPath <code>TEXPrintOrdChange/TPCXheader/refDoc/attachment/externalReference</code>) 0-99
fabPrintOperation	details of a fabric printing operation (XPath <code>TEXPrintOrdChange/TPCXbody/TPCXitem/fabPrintOperation</code>) 0-9
fabPrintSpecs	technical specifications of a fabric printing operation (XPath <code>TEXPrintOrdChange/TPCXbody/TPCXitem/fabPrintOperation/fabPrintSpecs</code>) 0-9
fabricComponent	identification details of a fabric used in a sub-contracted manufacturing operation (XPath <code>TEXPrintOrdChange/TPCXbody/TPCXitem/fabricComponent</code>) 0-9
fabricCompos	composition of the fabric according to the Directory 97/37/CE (XPath <code>TEXPrintOrdChange/TPCXbody/TPCXitem/fabricProd/fabricCompos</code>) 0-1
fabricProd	manufacturing specifications of the product to be obtained from an operation of the sub-contracted production of fabric

	(XPath <code>TEXPrintOrdChange/TPCXbody/TPCXitem/fabricProd</code>) 0-1
fabricSpecs	technical characteristics of fabric, linked either to an operation of subcontracted production or to the purchase (XPath <code>TEXPrintOrdChange/TPCXbody/TPCXitem/fabricProd/fabricSpecs</code>) 0-99
insPayment	payment details for payment by installments (XPath <code>TEXPrintOrdChange/terms/insPayment</code>) 0-5 - note: <i>excluded the case of offers, this set of data is alternative to payment set and must be iterated for each payment installment</i>
itemIdentification	serial identification of a product unit (XPath <code>TEXPrintOrdChange/TPCXbody/TPCXitem/fabricComponent/itemsList/itemIdentification</code>) 1-unbounded - note: <i>identification of the single product unit contained in the list</i>
itemsList	list of the single product units (XPath <code>TEXPrintOrdChange/TPCXbody/TPCXitem/fabricComponent/itemsList</code>) 0-unbounded - note: <i>it may be used to identify the pieces/chains that the Subcontractor must use for the commissioned work with multiple serial Ids for each one</i>
payment	payment details for payment all in one (XPath <code>TEXPrintOrdChange/terms/payment</code>) 0-5 - note: <i>excluded the case of offers, this set of data is alternative to insPayment, it can be iterated to specify alternative terms of payment (e.g.: 60 days or 30 days with 3% discount)</i>
piece	Identification data and measurement of the fabric piece. (XPath <code>TEXPrintOrdChange/TPCXbody/TPCXitem/fabricProd/piece</code>) 0-99
pieceChain	identification data and measurements of a chain of pieces still to be cut (XPath <code>TEXPrintOrdChange/TPCXbody/TPCXitem/fabricProd/pieceChain</code>) 0-99
pieceCut	identification data and measurements of a fabric piece belonging to a chain still to be cut (XPath <code>TEXPrintOrdChange/TPCXbody/TPCXitem/fabricProd/pieceChain/pieceCut</code>) 0-99 - note: <i>here the data of the pieces making up the chain should be specified</i>
piecePack	type of wrapping or packing of the fabric pieces (XPath <code>TEXPrintOrdChange/TPCXbody/TPCXitem/fabricProd/piece/piecePack</code>) 0-1 (XPath <code>TEXPrintOrdChange/TPCXbody/TPCXitem/fabricProd/pieceChain/piecePack</code>) 0-1
refDoc	identification of a document and of an item thereof, to which the message makes reference (XPath <code>TEXPrintOrdChange/TPCXheader/refDoc</code>) 1-9 (XPath <code>TEXPrintOrdChange/TPCXbody/TPCXitem/refDoc</code>) 1-9 (XPath <code>TEXPrintOrdChange/TPCXbody/TPCXitem/fabPrintOperation/refDoc</code>) 0-1 (XPath <code>TEXPrintOrdChange/TPCXbody/TPCXitem/fabricComponent/refDoc</code>) 0-1 - note: <i>here the delivery documents can be specified</i>
subContractor	details of the Sub-contractor - base type: Nad, (XPath <code>TEXPrintOrdChange/TPCXheader/subContractor</code>) 1-1
terms	details of the commercial obligations for payment and delivery (XPath <code>TEXPrintOrdChange/terms</code>) 0-1
texCode	full codification of the textile product (XPath <code>TEXPrintOrdChange/TPCXbody/TPCXitem/fabricProd/texCode</code>) 1-1

	(XPath TEXPrintOrdChange/TPCXbody/TPCXitem/fabricComponent/texCode) 1-1
thirdParty	details of the Third Party, different from Buyer or Supplier - base type: Nad, (XPath TEXPrintOrdChange/TPCXheader/thirdParty) 0-1 (XPath TEXPrintOrdChange/TPCXbody/TPCXitem/thirdParty) 0-1
TPCXbody	body of the document "TEXTILES PRINTING COMMISSION ORDER CHANGE" (XPath TEXPrintOrdChange/TPCXbody) 1-1
TPCXheader	header of the document "TEXTILES PRINTING COMMISSION ORDER CHANGE" (XPath TEXPrintOrdChange/TPCXheader) 1-1
TPCXitem	line item of the document "TEXTILES PRINTING COMMISSION ORDER CHANGE" (XPath TEXPrintOrdChange/TPCXbody/TPCXitem) 1-unbounded
trade	general terms of trade for the specified supply (XPath TEXPrintOrdChange/terms/trade) 0-1
transInfo	details of transport: mode, carrier and delivery place (XPath TEXPrintOrdChange/terms/transInfo) 0-5

2.2.2 Simple elements (Basic Business Information Entities)

Simple elements are those elements whose content is characterized by a data type plus a domain of possible values. Simple elements are alphabetically ordered.

AC_amount	amount of an Allowance or Charge - base type: decimal, fraction digits: 2, (XPath TEXPrintOrdChange/terms/allowanceCharge/AC_amount) 1-1
AC_category	coded specification of an Allowance or Charge - base type: string, cod. table: T41 http://www.ebiz.enea.it/moda-ml/repository/codelist/draft/gc_T41.xml (XPath TEXPrintOrdChange/terms/allowanceCharge/AC_category) 1-1
AC_categoryText	free text description of an Allowance or Charge - base type: string, max length: 250, (XPath TEXPrintOrdChange/terms/allowanceCharge/AC_categoryText) 1-1
AC_percent	amount of an Allowance or Charge as a percentage - base type: decimal, max inclusive: 100, fraction digits: 2, (XPath TEXPrintOrdChange/terms/allowanceCharge/AC_percent) 1-1
@act	status that the current line assigns to the line addressed in the reference document; if it is already canceled it maintains the status. - base type: string, cod. table: NT5 http://www.ebiz.enea.it/moda-ml/repository/codelist/draft/gc_NT5.xml (XPath TEXPrintOrdChange/TPCXbody/TPCXitem/@act) [Required]
added	additional code of the product (complementing the formers) - base type: string, max length: 80, (XPath TEXPrintOrdChange/TPCXbody/TPCXitem/fabricProduct/texCode/added) 0-9 - note: <i>here an additional codification (see table T44) can be specified</i> (XPath TEXPrintOrdChange/TPCXbody/TPCXitem/fabricComponent/texCode/added)) 0-9 - note: <i>here an additional codification (see table T44) can be specified</i>

additionalIdentifier	<p>additional identification code of a Party, for example customs registries or others</p> <p>- base type: string, max length: 15, (XPath <code>TEXPrintOrdChange/TPCXheader/buyer/additionalIdentifier</code>) 0-9</p> <p>- note: <i>identifiers for example for exports, such as MID (Manufacturer Identification Code), EORI (E.O.R.I. - Economic Operator Registration and Identification)</i></p>
@addType	<p>qualifier of the additional coding of a product</p> <p>- base type: string, cod. table: T44 http://www.ebiz.enea.it/moda-ml/repository/codelist/draft/gc_T44.xml</p> <p>(XPath <code>TEXPrintOrdChange/TPCXbody/TPCXitem/fabricComponent/texCode/added/@addType</code>) [Optional]</p> <p>- nota: <i>addType allows the clarification of the meaning of the added element content; it is strongly suggested to use it always.</i> (XPath <code>TEXPrintOrdChange/TPCXbody/TPCXitem/fabricProd/texCode/added/@addType</code>) [Optional]</p> <p>- nota: <i>addType allows the clarification of the meaning of the added element content; it is strongly suggested to use it always.</i></p>
@application	<p>force or similar condition (e.g. no. of revolutions) applied in a test as specified within the standard</p> <p>- base type: string, max length: 15, (XPath <code>TEXPrintOrdChange/TPCXbody/TPCXitem/fabPrintOperation/fabPrintSpecs/specValue/@application</code>) [Optional] (XPath <code>TEXPrintOrdChange/TPCXbody/TPCXitem/fabricProd/fabricSpecs/specValue/@application</code>) [Optional]</p>
art	<p>article number of the product</p> <p>- base type: string, max length: 80, (XPath <code>TEXPrintOrdChange/TPCXbody/TPCXitem/fabricComponent/texCode/art</code>) 1-1</p> <p>- note: <i>can be used either for the base-article (excluding pattern/colour) or for the SKU</i> (XPath <code>TEXPrintOrdChange/TPCXbody/TPCXitem/fabricProd/texCode/art</code>) 1-1</p> <p>- note: <i>can be used either for the base-article (excluding pattern/colour) or for the SKU</i></p>
binaryObject	<p>a binary large object containing an attached document</p> <p>- base type: base64Binary, (XPath <code>TEXPrintOrdChange/TPCXbody/TPCXitem/fabricComponent/refDoc/attachment/binaryObject</code>) 0-1 (XPath <code>TEXPrintOrdChange/TPCXheader/refDoc/attachment/binaryObject</code>) 0-1 (XPath <code>TEXPrintOrdChange/TPCXbody/TPCXitem/fabPrintOperation/refDoc/attachment/binaryObject</code>) 0-1 (XPath <code>TEXPrintOrdChange/TPCXbody/TPCXitem/refDoc/attachment/binaryObject</code>) 0-1</p>
carrier	<p>identification of the transport carrier</p> <p>- base type: string, max length: 40, (XPath <code>TEXPrintOrdChange/terms/transInfo/carrier</code>) 0-1</p>
@characterSet	<p>the character set of the binary object if the mime type is text</p> <p>- base type: normalizedString, (XPath <code>TEXPrintOrdChange/TPCXbody/TPCXitem/fabricComponent/refDoc/attachment/binaryObject/@characterSet</code>) [Optional] (XPath <code>TEXPrintOrdChange/TPCXheader/refDoc/attachment/binaryObject/@characterSet</code>) [Optional]</p>

	<p>(XPath TEXPrintOrdChange/TPCXbody/TPCXitem/fabPrintOperation/refDoc/attachment/binaryObject/@characterSet) [Optional] (XPath TEXPrintOrdChange/TPCXbody/TPCXitem/refDoc/attachment/binaryObject/@characterSet) [Optional]</p>
characterSetCode	<p>the character set of an external document - base type: normalizedString, (XPath TEXPrintOrdChange/TPCXbody/TPCXitem/fabricComponent/refDoc/attachment/externalReference/characterSetCode) 0-1 (XPath TEXPrintOrdChange/TPCXheader/refDoc/attachment/externalReference/characterSetCode) 0-1 (XPath TEXPrintOrdChange/TPCXbody/TPCXitem/refDoc/attachment/externalReference/characterSetCode) 0-1 (XPath TEXPrintOrdChange/TPCXbody/TPCXitem/fabPrintOperation/refDoc/attachment/externalReference/characterSetCode) 0-1</p>
city	<p>name of the city (town, village) - base type: string, max length: 40, (XPath TEXPrintOrdChange/TPCXheader/buyer/city) 0-1 (XPath TEXPrintOrdChange/TPCXbody/TPCXitem/thirdParty/city) 0-1 (XPath TEXPrintOrdChange/TPCXheader/thirdParty/city) 0-1 (XPath TEXPrintOrdChange/TPCXheader/subContractor/city) 0-1</p>
@codeList	<p>it specifies the URL where the list of codes used to make an instance of the element can be found - base type: string, max length: 255, (XPath TEXPrintOrdChange/TPCXbody/TPCXitem/fabPrintOperation/note/@codeList) [Optional] - nota: <i>must be used to provide (URL) the list of codes used in "noteLabel"</i> (XPath TEXPrintOrdChange/TPCXbody/TPCXitem/fabricComponent/texCode/color/@codeList) [Optional] - nota: <i>this attribute could be used as alternative to the others</i> (XPath TEXPrintOrdChange/TPCXbody/TPCXitem/fabricComponent/refDoc/season/@codeList) [Optional] (XPath TEXPrintOrdChange/TPCXbody/TPCXitem/fabricComponent/itemsList/qualityLevel/@codeList) [Optional] (XPath TEXPrintOrdChange/TPCXheader/note/@codeList) [Optional] - nota: <i>must be used to provide (URL) the list of codes used in "noteLabel"</i> (XPath TEXPrintOrdChange/TPCXbody/TPCXitem/refDoc/season/@codeList) [Optional] (XPath TEXPrintOrdChange/TPCXbody/TPCXitem/fabPrintOperation/refDoc/season/@codeList) [Optional] (XPath TEXPrintOrdChange/TPCXbody/TPCXitem/fabricProd/texCode/art/@codeList) [Optional] - nota: <i>this attribute should be ALTERNATIVE to the others</i> (XPath TEXPrintOrdChange/TPCXbody/TPCXitem/fabricProd/texCode/color/@codeList) [Optional] - nota: <i>this attribute could be used as alternative to the others</i> (XPath TEXPrintOrdChange/TPCXbody/TPCXitem/fabricProd/texCode/pattern/@codeList) [Optional] - nota: <i>this attribute should be ALTERNATIVE to the others</i> (XPath TEXPrintOrdChange/TPCXbody/TPCXitem/fabricComponent/note/@codeList) [Optional] - nota: <i>must be used to provide (URL) the list of codes used in "noteLabel"</i> (XPath TEXPrintOrdChange/TPCXbody/TPCXitem/fabricComponent/texCode/art/@codeList) [Optional] - nota: <i>this attribute should be ALTERNATIVE to the others</i></p>

	<p>(XPath TEXPrintOrdChange/TPCXbody/TPCXitem/fabricComponent/texCode/pattern/@codeList) [Optional]</p> <p>- nota: <i>this attribute should be ALTERNATIVE to the others</i></p> <p>(XPath TEXPrintOrdChange/TPCXbody/TPCXitem/fabricProduct/note/@codeList) [Optional]</p> <p>- nota: <i>must be used to provide (URL) the list of codes used in "noteLabel"</i></p> <p>(XPath TEXPrintOrdChange/terms/allowanceCharge/dtScheme/note/@codeList) [Optional]</p> <p>- nota: <i>must be used to provide (URL) the list of codes used in "noteLabel"</i></p> <p>(XPath TEXPrintOrdChange/terms/allowanceCharge/dtScheme/legalRef/@codeList) [Required]</p> <p>(XPath TEXPrintOrdChange/TPCXheader/season/@codeList) [Optional]</p> <p>(XPath TEXPrintOrdChange/TPCXheader/refDoc/season/@codeList) [Optional]</p> <p>(XPath TEXPrintOrdChange/TPCXbody/TPCXitem/dtScheme/note/@codeList) [Optional]</p> <p>- nota: <i>must be used to provide (URL) the list of codes used in "noteLabel"</i></p> <p>(XPath TEXPrintOrdChange/TPCXbody/TPCXitem/dtScheme/legalRef/@codeList) [Required]</p>
color	<p>colour number of the product, when not included in the model or fabric code</p> <p>- base type: string, max length: 15,</p> <p>(XPath TEXPrintOrdChange/TPCXbody/TPCXitem/fabricProduct/texCode/color) 0-1</p> <p>(XPath TEXPrintOrdChange/TPCXbody/TPCXitem/fabricComponent/texCode/color) 0-1</p>
country	<p>code of the nation</p> <p>- base type: string, cod. table: T10</p> <p>http://www.ebiz.enea.it/moda-ml/repository/codelist/draft/gc_T10.xml</p> <p>(XPath TEXPrintOrdChange/TPCXbody/TPCXitem/thirdParty/country) 0-1</p> <p>(XPath TEXPrintOrdChange/TPCXheader/subContractor/country) 0-1</p> <p>(XPath TEXPrintOrdChange/TPCXheader/buyer/country) 0-1</p> <p>(XPath TEXPrintOrdChange/TPCXheader/thirdParty/country) 0-1</p>
@CTest	<p>indicates the need to execute a colour test before the operation</p> <p>- base type: string, cod. table: NT38</p> <p>http://www.ebiz.enea.it/moda-ml/repository/codelist/draft/gc_NT38.xml</p> <p>(XPath TEXPrintOrdChange/TPCXbody/TPCXitem/fabricProduct/@CTest) [Optional]</p>
@currency	<p>currency in which a specified monetary data is expressed</p> <p>- base type: string, cod. table: T9</p> <p>http://www.ebiz.enea.it/moda-ml/repository/codelist/draft/gc_T9.xml</p> <p>(XPath TEXPrintOrdChange/TPCXbody/TPCXitem/price/@currency) [Optional]</p> <p>- nota: <i>Currency referred by the price.</i></p> <p>(XPath TEXPrintOrdChange/terms/allowanceCharge/@currency) [Optional]</p>
@CV	<p>coefficient of variation (CV) of a measurement</p> <p>- base type: decimal,</p> <p>(XPath TEXPrintOrdChange/TPCXbody/TPCXitem/fabPrintOperation/fabPrintSpecs/specValue/@CV) [Optional]</p> <p>(XPath TEXPrintOrdChange/TPCXbody/TPCXitem/fabricProduct/fabricSpecs/specValue/@CV) [Optional]</p>
@dateForm	<p>format used for the date</p> <p>- base type: string, cod. table: NT29</p> <p>http://www.ebiz.enea.it/moda-ml/repository/codelist/draft/gc_NT29.xml</p> <p>(XPath TEXPrintOrdChange/TPCXbody/TPCXitem/fabPrintOperation/refDoc/docDate/@dateForm) [Optional]</p> <p>(XPath TEXPrintOrdChange/TPCXheader/msgDate/@dateForm) [Optional]</p> <p>(XPath TEXPrintOrdChange/TPCXbody/TPCXitem/deliveryDate/@dateForm) [Optional]</p> <p>(XPath TEXPrintOrdChange/terms/transInfo/delEffectiveDate/@dateForm) [Optional]</p> <p>(XPath TEXPrintOrdChange/TPCXheader/refDoc/docDate/@dateForm) [Optional]</p> <p>(XPath TEXPrintOrdChange/terms/transInfo/despatchDate/@dateForm) [Optional]</p>

	(XPath <code>TEXPrintOrdChange/TPCXbody/TPCXitem/refDoc/docDate/@dateForm</code>) [Optional] (XPath <code>TEXPrintOrdChange/TPCXbody/TPCXitem/fabricComponent/refDoc/docDate/@dateForm</code>) [Optional]
delEffectiveDate	effective date of delivery of goods (declared in Despatch), according to one of the patterns YYYY-MM-DD, YYYY-MM-DD:HH-MM or YYYY-WW. - base type: string, (XPath <code>TEXPrintOrdChange/terms/transInfo/delEffectiveDate</code>) 0-1
deliveryDate	date of delivery of goods, requested or promised in the purchase process, according to one of the patterns YYYY-MM-DD, YYYY-MM-DD:HH-MM or YYYY-WW. - base type: string, (XPath <code>TEXPrintOrdChange/TPCXbody/TPCXitem/deliveryDate</code>) 0-1
deliveryPlace	place of delivery of goods, ultimate or related to a given leg - base type: string, max length: 250, (XPath <code>TEXPrintOrdChange/terms/transInfo/deliveryPlace</code>) 0-1
dept	name or code of a contact department within a Party - base type: string, max length: 40, (XPath <code>TEXPrintOrdChange/TPCXheader/subContractor/dept</code>) 0-1 (XPath <code>TEXPrintOrdChange/TPCXheader/buyer/dept</code>) 0-1 (XPath <code>TEXPrintOrdChange/TPCXheader/thirdParty/dept</code>) 0-1 (XPath <code>TEXPrintOrdChange/TPCXbody/TPCXitem/thirdParty/dept</code>) 0-1
description	free text description. The content of the element must be unique, it might be translated and repeated into more languages (thus no more than one instance for each language). - base type: string, max length: 250, (XPath <code>TEXPrintOrdChange/TPCXbody/TPCXitem/fabricProductCode/description</code>) 0-unbounded - note: <i>Product description</i> (XPath <code>TEXPrintOrdChange/TPCXbody/TPCXitem/fabricComponent/textCode/description</code>) 0-unbounded - note: <i>Product description</i>
despatchDate	date of despatch of goods, requested or promised in the purchase process, according to one of the patterns YYYY-MM-DD, YYYY-MM-DD:HH-MM or YYYY-WW. - base type: string, (XPath <code>TEXPrintOrdChange/terms/transInfo/despatchDate</code>) 0-1
despatchPlace	place of despatch of goods, origin or related to a given leg - base type: string, max length: 250, (XPath <code>TEXPrintOrdChange/terms/transInfo/despatchPlace</code>) 0-1
docDate	date of issue of the referenced document, according to one of the patterns YYYY-MM-DD, YYYY-MM-DD:HH-MM or YYYY-WW. - base type: string, (XPath <code>TEXPrintOrdChange/TPCXbody/TPCXitem/refDoc/docDate</code>) 0-1 (XPath <code>TEXPrintOrdChange/TPCXbody/TPCXitem/fabricPrintOperation/refDoc/docDate</code>) 0-1 (XPath <code>TEXPrintOrdChange/TPCXbody/TPCXitem/fabricComponent/refDoc/docDate</code>) 0-1 (XPath <code>TEXPrintOrdChange/TPCXheader/refDoc/docDate</code>) 0-1
docID	identification number of the referenced document SINCE 2008-1 ITS USE IN THE HEADER IS DISCOURAGED (REPLACED BY msgID) - base type: string, max length: 80, (XPath <code>TEXPrintOrdChange/TPCXheader/docID</code>) 0-1

	<p>(XPath TEXPrintOrdChange/TPCXbody/TPCXitem/fabPrintOperation/refDoc/docID) 1-2 (XPath TEXPrintOrdChange/TPCXbody/TPCXitem/fabricComponent/refDoc/docID) 1-2 (XPath TEXPrintOrdChange/TPCXbody/TPCXitem/refDoc/docID) 1-2 (XPath TEXPrintOrdChange/TPCXheader/refDoc/docID) 1-2</p>
@docType	<p>type or class to which the referenced document belongs - base type: string, cod. table: T21 http://www.ebiz.enea.it/moda-ml/repository/codelist/draft/gc_T21.xml (XPath TEXPrintOrdChange/TPCXheader/refDoc/@docType) [Required] (XPath TEXPrintOrdChange/TPCXbody/TPCXitem/fabricComponent/refDoc/@docType) [Required] (XPath TEXPrintOrdChange/TPCXbody/TPCXitem/refDoc/@docType) [Required] (XPath TEXPrintOrdChange/TPCXbody/TPCXitem/fabPrintOperation/refDoc/@docType) [Required]</p>
dyeN	<p>number of the dyeing batch of a textile product - base type: string, max length: 15, (XPath TEXPrintOrdChange/TPCXbody/TPCXitem/fabricProd/pieceChain/dyeN) 0-1 (XPath TEXPrintOrdChange/TPCXbody/TPCXitem/fabricProd/piece/dyeN) 0-1</p>
dyeStuff	<p>dye stuff used in the fabric dye process - base type: string, cod. table: T16 http://www.ebiz.enea.it/moda-ml/repository/codelist/draft/gc_T16.xml (XPath TEXPrintOrdChange/TPCXbody/TPCXitem/fabPrintOperation/dyeStuff) 0-1</p>
@email	<p>electronic mail address of the contact person within a Party - base type: string, max length: 250, (XPath TEXPrintOrdChange/TPCXheader/subContractor/person/@email) [Optional] (XPath TEXPrintOrdChange/TPCXheader/buyer/person/@email) [Optional] (XPath TEXPrintOrdChange/TPCXheader/thirdParty/person/@email) [Optional] (XPath TEXPrintOrdChange/TPCXbody/TPCXitem/thirdParty/person/@email) [Optional]</p>
@encoding	<p>specifies the decoding algorithm of the binary object - base type: normalizedString, (XPath TEXPrintOrdChange/TPCXbody/TPCXitem/fabPrintOperation/refDoc/attachment/binaryObject/@encoding) [Optional] (XPath TEXPrintOrdChange/TPCXheader/refDoc/attachment/binaryObject/@encoding) [Optional] (XPath TEXPrintOrdChange/TPCXbody/TPCXitem/refDoc/attachment/binaryObject/@encoding) [Optional] (XPath TEXPrintOrdChange/TPCXbody/TPCXitem/fabricComponent/refDoc/attachment/binaryObject/@encoding) [Optional]</p>
encodingCode	<p>the encoding/decoding algorithm used with the external object - base type: normalizedString, (XPath TEXPrintOrdChange/TPCXbody/TPCXitem/fabricComponent/refDoc/attachment/externalReference/encodingCode) 0-1 (XPath TEXPrintOrdChange/TPCXbody/TPCXitem/refDoc/attachment/externalReference/encodingCode) 0-1 (XPath TEXPrintOrdChange/TPCXbody/TPCXitem/fabPrintOperation/refDoc/attachment/externalReference/encodingCode) 0-1 (XPath TEXPrintOrdChange/TPCXheader/refDoc/attachment/externalReference/encodingCode) 0-1</p>

@endUse	<p>specifies the final use of the fabric</p> <ul style="list-style-type: none"> - base type: string, cod. table: NT4 http://www.ebiz.enea.it/moda-ml/repository/codelist/draft/gc_NT4.xml (XPath <code>TEXPrintOrdChange/TPCXbody/TPCXitem/fabricProd/piece/@endUse</code>) [Optional]
EPC	<p>serial identifier used for tracing a physical item with RFID technology</p> <ul style="list-style-type: none"> - base type: string, (XPath <code>TEXPrintOrdChange/TPCXbody/TPCXitem/fabricProd/piece/EPC</code>) 0-1 - note: <i>the use of this element is DEPRECATED, use the appropriate elements (serialN)</i>
fabPrintChar	<p>code specifying a characteristic or parameter of the fabric printing</p> <ul style="list-style-type: none"> - base type: string, cod. table: T45 http://www.ebiz.enea.it/moda-ml/repository/codelist/draft/gc_T45.xml (XPath <code>TEXPrintOrdChange/TPCXbody/TPCXitem/fabPrintOperation/fabPrintSpecs/fabPrintChar</code>) 1-1
fabPrintCharText	<p>free text describing a characteristic or parameter of the fabric printing</p> <ul style="list-style-type: none"> - base type: string, max length: 250, (XPath <code>TEXPrintOrdChange/TPCXbody/TPCXitem/fabPrintOperation/fabPrintSpecs/fabPrintCharText</code>) 1-1
fabPrintTech	<p>operation technology used for fabric printing</p> <ul style="list-style-type: none"> - base type: string, cod. table: T264 http://www.ebiz.enea.it/moda-ml/repository/codelist/draft/gc_T264.xml (XPath <code>TEXPrintOrdChange/TPCXbody/TPCXitem/fabPrintOperation/fabPrintTech</code>) 1-1
fabricChar	<p>code of the physical or mechanical parameter used to define a "technical characteristic of the fabric" (see Fabric technical sheet)</p> <ul style="list-style-type: none"> - base type: string, cod. table: T13 http://www.ebiz.enea.it/moda-ml/repository/codelist/draft/gc_T13.xml (XPath <code>TEXPrintOrdChange/TPCXbody/TPCXitem/fabricProd/fabricSpecs/fabricChar</code>) 1-1
fabricCharText	<p>free text describing the physical or mechanical parameter used to define a "technical characteristic of the fabric"</p> <ul style="list-style-type: none"> - base type: string, max length: 80, (XPath <code>TEXPrintOrdChange/TPCXbody/TPCXitem/fabricProd/fabricSpecs/fabricCharText</code>) 1-1
fabricWidth	<p>width of the fabric as technical specification</p> <ul style="list-style-type: none"> - base type: decimal, min inclusive: 0, fraction digits: 2, (XPath <code>TEXPrintOrdChange/TPCXbody/TPCXitem/fabricProd/fabricWidth</code>) 0-1
@fax	<p>fax number of the contact person within a Party</p> <ul style="list-style-type: none"> - base type: string, max length: 35, (XPath <code>TEXPrintOrdChange/TPCXheader/thirdParty/person/@fax</code>) [Optional] (XPath <code>TEXPrintOrdChange/TPCXbody/TPCXitem/thirdParty/person/@fax</code>) [Optional] (XPath <code>TEXPrintOrdChange/TPCXheader/subContractor/person/@fax</code>) [Optional] (XPath <code>TEXPrintOrdChange/TPCXheader/buyer/person/@fax</code>) [Optional]
@fibre	<p>type of fibre used in a textile product</p> <ul style="list-style-type: none"> - base type: string, cod. table: T19 http://www.ebiz.enea.it/moda-ml/repository/codelist/draft/gc_T19.xml (XPath <code>TEXPrintOrdChange/TPCXbody/TPCXitem/fabricProd/fabricCompos/percCompos/@fibre</code>) [Required]
fileName	<p>unique identifier (name) of the file</p> <ul style="list-style-type: none"> - base type: string, max length: 255,

	<p>(XPath TEXPrintOrdChange/TPCXbody/TPCXitem/fabPrintOperation/refDoc/attachment/fileName) 0-1 (XPath TEXPrintOrdChange/TPCXheader/refDoc/attachment/fileName) 0-1 (XPath TEXPrintOrdChange/TPCXbody/TPCXitem/fabricComponent/refDoc/attachment/fileName) 0-1 (XPath TEXPrintOrdChange/TPCXbody/TPCXitem/refDoc/attachment/fileName) 0-1</p>
@finDiscount	<p>financial discount rate applied for payment by the date specified - base type: decimal, min inclusive: 0, max inclusive: 100, fraction digits: 2, (XPath TEXPrintOrdChange/terms/payment/@finDiscount) [Optional]</p>
@finSurcharge	<p>financial surcharge rate applied for payment after the date specified - base type: decimal, min inclusive: 0, max inclusive: 100, fraction digits: 2, (XPath TEXPrintOrdChange/terms/payment/@finSurcharge) [Optional]</p>
@format	<p>the format of the binary content - base type: string, (XPath TEXPrintOrdChange/TPCXheader/refDoc/attachment/binaryObject/@format) [Optional] (XPath TEXPrintOrdChange/TPCXbody/TPCXitem/fabPrintOperation/refDoc/attachment/binaryObject/@format) [Optional] (XPath TEXPrintOrdChange/TPCXbody/TPCXitem/refDoc/attachment/binaryObject/@format) [Optional] (XPath TEXPrintOrdChange/TPCXbody/TPCXitem/fabricComponent/refDoc/attachment/binaryObject/@format) [Optional]</p>
formatCode	<p>the format of the external object - base type: normalizedString, (XPath TEXPrintOrdChange/TPCXbody/TPCXitem/fabricComponent/refDoc/attachment/externalReference/formatCode) 0-1 (XPath TEXPrintOrdChange/TPCXbody/TPCXitem/refDoc/attachment/externalReference/formatCode) 0-1 (XPath TEXPrintOrdChange/TPCXbody/TPCXitem/fabPrintOperation/refDoc/attachment/externalReference/formatCode) 0-1 (XPath TEXPrintOrdChange/TPCXheader/refDoc/attachment/externalReference/formatCode) 0-1</p>
grossWeight	<p>the gross weight, declared for transport or customs purpose - base type: decimal, min inclusive: 0, fraction digits: 2, (XPath TEXPrintOrdChange/TPCXbody/TPCXitem/fabricProd/piece/grossWeight) 0-1 - note: <i>gross Weight is related to the weight of the piece after packing.</i> (XPath TEXPrintOrdChange/terms/transInfo/grossWeight) 0-1</p>
groundColor	<p>ground colour related to a printing screen - base type: string, max length: 15, (XPath TEXPrintOrdChange/TPCXbody/TPCXitem/fabPrintOperation/groundColor) 0-9</p>
id	<p>primary identification code of a Party; it is recommended the format: nation code (ISO 3166) + VAT identification number (11 crt), with the qualifier "numbingOrg"= MF - base type: string, max length: 15, (XPath TEXPrintOrdChange/TPCXheader/buyer/id) 1-1 (XPath TEXPrintOrdChange/TPCXbody/TPCXitem/thirdParty/id) 1-1 (XPath TEXPrintOrdChange/TPCXheader/subContractor/id) 1-1 (XPath TEXPrintOrdChange/TPCXheader/thirdParty/id) 1-1</p>

@idQualifier	<p>Qualification of the identifier.</p> <ul style="list-style-type: none"> - base type: string, (XPath TEXPrintOrdChange/TPCXheader/buyer/additionalIdentifier/@idQualifier) [Optional] - nota: <i>this attribute should be used when the numberingOrg attribute is not enough to declare the type of identifier</i> (XPath TEXPrintOrdChange/TPCXbody/TPCXitem/fabricProd/pieceChain/serialN/@idQualifier) [Optional] - nota: <i>this attribute should be used when the numberingOrg attribute is not enough to declare the type of serial identifier</i> (XPath TEXPrintOrdChange/TPCXbody/TPCXitem/fabricComponent/itemsList/itemIdentification/serialN/@idQualifier) [Optional] - nota: <i>this attribute should be used when the numberingOrg attribute is not enough to declare the type of serial identifier</i> (XPath TEXPrintOrdChange/TPCXbody/TPCXitem/fabricProd/piece/serialN/@idQualifier) [Optional] - nota: <i>this attribute should be used when the numberingOrg attribute is not enough to declare the type of serial identifier</i> (XPath TEXPrintOrdChange/TPCXbody/TPCXitem/fabricProd/pieceChain/pieceCut/serialN/@idQualifier) [Optional] - nota: <i>this attribute should be used when the numberingOrg attribute is not enough to declare the type of serial identifier</i> (XPath TEXPrintOrdChange/TPCXbody/TPCXitem/fabricComponent/serialN/@idQualifier) [Optional] - nota: <i>this attribute should be used when the numberingOrg attribute is not enough to declare the type of serial identifier</i>
incoTerm	<p>specification of the terms of trade (INCOTERMS)</p> <ul style="list-style-type: none"> - base type: string, cod. table: T3 http://www.ebiz.enea.it/moda-ml/repository/codelist/draft/gc_T3.xml (XPath TEXPrintOrdChange/terms/trade/incoTerm) 1-1
incoTermText	<p>free text specifying the terms of trade (incoterm, location)</p> <ul style="list-style-type: none"> - base type: string, max length: 250, (XPath TEXPrintOrdChange/terms/trade/incoTermText) 1-1
@isURL	<p>it indicates if the referred element is an URL (true) or not (false)</p> <ul style="list-style-type: none"> - base type: boolean, (XPath TEXPrintOrdChange/TPCXbody/TPCXitem/fabricComponent/refDoc/attachment/externalReference/uri/@isURL) [Optional] [Default= true] - nota: <i>usage of URLs is recommended</i> (XPath TEXPrintOrdChange/TPCXheader/refDoc/attachment/externalReference/uri/@isURL) [Optional] [Default= true] - nota: <i>usage of URLs is recommended</i> (XPath TEXPrintOrdChange/TPCXbody/TPCXitem/fabPrintOperation/refDoc/attachment/externalReference/uri/@isURL) [Optional] [Default= true] - nota: <i>usage of URLs is recommended</i> (XPath TEXPrintOrdChange/TPCXbody/TPCXitem/refDoc/attachment/externalReference/uri/@isURL) [Optional] [Default= true] - nota: <i>usage of URLs is recommended</i>
itemID	<p>number of the line/item of the referenced document</p> <ul style="list-style-type: none"> - base type: string, max length: 6, (XPath TEXPrintOrdChange/TPCXbody/TPCXitem/fabPrintOperation/refDoc/itemID) 0-1 (XPath TEXPrintOrdChange/TPCXheader/refDoc/itemID) 0-1 (XPath TEXPrintOrdChange/TPCXbody/TPCXitem/refDoc/itemID) 0-1 (XPath TEXPrintOrdChange/TPCXbody/TPCXitem/fabricComponent/refDoc/itemID) 0-1

legalName	<p>legal name of a Party</p> <p>- base type: string, max length: 250, (XPath TEXPrintOrdChange/TPCXbody/TPCXitem/thirdParty/legalName) 0-1 (XPath TEXPrintOrdChange/TPCXheader/buyer/legalName) 0-1 (XPath TEXPrintOrdChange/TPCXheader/subContractor/legalName) 0-1 (XPath TEXPrintOrdChange/TPCXheader/thirdParty/legalName) 0-1</p>
legalRef	<p>legal reference of the duty or tax or fee category</p> <p>- base type: string, (XPath TEXPrintOrdChange/TPCXbody/TPCXitem/dtScheme/legalRef) 0-1 (XPath TEXPrintOrdChange/terms/allowanceCharge/dtScheme/legalRef) 0-1</p>
lineN	<p>number of the line item of the present message (xml document); it is set by the role that produces the document. Usually it is a progressive number, but not always.</p> <p>- base type: positiveInteger, min inclusive: 1, max inclusive: 9999, (XPath TEXPrintOrdChange/TPCXbody/TPCXitem/lineN) 1-1</p>
@listName	<p>the name of the list of codes used to make an instance of the element (it might be thought as descriptive element, i.e. 'fabric printing technologies', or not, i.e. "T264")</p> <p>- base type: string, max length: 40, (XPath TEXPrintOrdChange/TPCXheader/season/@listName) [Optional] (XPath TEXPrintOrdChange/TPCXbody/TPCXitem/fabricComponent/refDoc/season/@listName) [Optional] (XPath TEXPrintOrdChange/TPCXbody/TPCXitem/fabPrintOperation/refDoc/season/@listName) [Optional] (XPath TEXPrintOrdChange/TPCXbody/TPCXitem/fabricComponent/texCode/pattern/@listName) [Optional]</p> <p>- nota: <i>this attribute should always be used coupled with "numberingOrg"</i> (XPath TEXPrintOrdChange/TPCXbody/TPCXitem/fabricProd/texCode/pattern/@listName) [Optional]</p> <p>- nota: <i>this attribute should always be used coupled with "numberingOrg"</i> (XPath TEXPrintOrdChange/TPCXbody/TPCXitem/fabricProd/texCode/art/@listName) [Optional]</p> <p>- nota: <i>this attribute should always be used coupled with "numberingOrg"</i> (XPath TEXPrintOrdChange/TPCXheader/refDoc/season/@listName) [Optional] (XPath TEXPrintOrdChange/TPCXbody/TPCXitem/fabricComponent/texCode/color/@listName) [Optional]</p> <p>- nota: <i>this attribute should always be used coupled with "numberingOrg"</i> (XPath TEXPrintOrdChange/TPCXbody/TPCXitem/fabricComponent/itemsList/qualityLevel/@listName) [Optional] (XPath TEXPrintOrdChange/TPCXbody/TPCXitem/refDoc/season/@listName) [Optional] (XPath TEXPrintOrdChange/TPCXbody/TPCXitem/fabricComponent/texCode/art/@listName) [Optional]</p> <p>- nota: <i>this attribute should always be used coupled with "numberingOrg"</i> (XPath TEXPrintOrdChange/TPCXbody/TPCXitem/fabricProd/texCode/color/@listName) [Optional]</p> <p>- nota: <i>this attribute should always be used coupled with "numberingOrg"</i></p>
@listVersion	<p>it specifies the version of the list of codes used to make an instance of the element</p> <p>- base type: string, max length: 6, (XPath TEXPrintOrdChange/TPCXbody/TPCXitem/fabricComponent/refDoc/season/@listVersion) [Optional] (XPath TEXPrintOrdChange/TPCXbody/TPCXitem/fabricProd/texCode/art/@listVersion) [Optional]</p>

	<p>- nota: <i>this attribute should always be used coupled with “numberingOrg” and “listName”</i> (XPath TEXPrintOrdChange/TPCXheader/refDoc/season/@listVersion) [Optional] (XPath TEXPrintOrdChange/TPCXheader/season/@listVersion) [Optional] (XPath TEXPrintOrdChange/TPCXbody/TPCXitem/fabricProd/ texCode/pattern/@listVersion) [Optional]</p> <p>- nota: <i>this attribute should always be used coupled with “numberingOrg” and “listName”</i> (XPath TEXPrintOrdChange/TPCXbody/TPCXitem/fabricComponent/texCode/art/@listVersion) [Optional]</p> <p>- nota: <i>this attribute should always be used coupled with “numberingOrg” and “listName”</i> (XPath TEXPrintOrdChange/TPCXbody/TPCXitem/fabricComponent/texCode/pattern/@listVersion) [Optional]</p> <p>- nota: <i>this attribute should always be used coupled with “numberingOrg” and “listName”</i> (XPath TEXPrintOrdChange/TPCXbody/TPCXitem/fabricComponent/texCode/color/@listVersion) [Optional]</p> <p>- nota: <i>this attribute should always be used coupled with “numberingOrg” and “listName”</i> (XPath TEXPrintOrdChange/TPCXbody/TPCXitem/refDoc/season/@listVersion) [Optional] (XPath TEXPrintOrdChange/TPCXbody/TPCXitem/fabPrintOperation/refDoc/season/@listVersion) [Optional]</p> <p>- nota: <i>this attribute should always be used coupled with “numberingOrg” and “listName”</i> (XPath TEXPrintOrdChange/TPCXbody/TPCXitem/fabricComponent/itemsList/qualityLevel/@listVersion) [Optional] (XPath TEXPrintOrdChange/TPCXbody/TPCXitem/fabricProd/ texCode/color/@listVersion) [Optional]</p> <p>- nota: <i>this attribute should always be used coupled with “numberingOrg” and “listName”</i></p>
@ln	<p>Language code. - base type: string, (XPath TEXPrintOrdChange/TPCXbody/TPCXitem/fabricComponent/texCode/description/@ln) [Optional] (XPath TEXPrintOrdChange/TPCXbody/TPCXitem/fabricProd/ texCode/description/@ln) [Optional]</p>
location	<p>specification of a location - base type: string, max length: 40, (XPath TEXPrintOrdChange/terms/trade/location) 0-1 - note: <i>place to which the INCOTERM applies</i> (XPath TEXPrintOrdChange/TPCXbody/TPCXitem/fabricComponent/location) 0-1 - note: <i>it may be used to specify the location where lie the pieces that the Subcontractor must use for the commissioned work operation</i></p>
@logo	<p>company logo (URL of the image jpeg or gif). It is recommended that the width of the image does not exceed 640 pixel. - base type: string, max length: 255, (XPath TEXPrintOrdChange/TPCXheader/buyer/@logo) [Optional]</p>
lotN	<p>lot number of a product or batch number of the raw material - base type: string, max length: 15, (XPath TEXPrintOrdChange/TPCXbody/TPCXitem/fabricProd/ piece/lotN) 0-2 - note: <i>The lotN instances must differ by value of the numberingOrg attribute</i> (XPath TEXPrintOrdChange/TPCXbody/TPCXitem/fabricProd/ pieceChain/lotN) 0-1</p>

@LRI	<p>attribute usable to format a string according to a customized User rule (local rule)</p> <p>- base type: string, cod. table: NT3 http://www.ebiz.enea.it/moda-ml/repository/codelist/draft/gc_NT3.xml (XPath TEXPrintOrdChange/TPCXbody/TPCXitem/fabricComponent/location/@LRI) [Optional] (XPath TEXPrintOrdChange/terms/trade/location/@LRI) [Optional]</p>
@maxQty	<p>maximum product quantity</p> <p>- base type: decimal, min inclusive: 0, fraction digits: 2, (XPath TEXPrintOrdChange/terms/allowanceCharge/@maxQty) [Optional]</p> <p>- nota: <i>maximum quantity of product for the application of this allowance or charge</i></p>
@method	<p>standard protocol or method employed in a test to evaluate a characteristic or a parameter</p> <p>- base type: string, max length: 80, (XPath TEXPrintOrdChange/TPCXbody/TPCXitem/fabPrintOperation/fabPrintSpecs/specValue/@method) [Optional] (XPath TEXPrintOrdChange/TPCXbody/TPCXitem/fabricProd/fabricSpecs/specValue/@method) [Optional]</p>
@mime	<p>the mime type of the binary object</p> <p>- base type: normalizedString, (XPath TEXPrintOrdChange/TPCXheader/refDoc/attachment/binaryObject/@mime) [Optional] (XPath TEXPrintOrdChange/TPCXbody/TPCXitem/fabPrintOperation/refDoc/attachment/binaryObject/@mime) [Optional] (XPath TEXPrintOrdChange/TPCXbody/TPCXitem/refDoc/attachment/binaryObject/@mime) [Optional] (XPath TEXPrintOrdChange/TPCXbody/TPCXitem/fabricComponent/refDoc/attachment/binaryObject/@mime) [Optional]</p>
mimeCode	<p>mime type of the external object</p> <p>- base type: normalizedString, (XPath TEXPrintOrdChange/TPCXbody/TPCXitem/fabPrintOperation/refDoc/attachment/externalReference/mimeCode) 0-1 (XPath TEXPrintOrdChange/TPCXbody/TPCXitem/refDoc/attachment/externalReference/mimeCode) 0-1 (XPath TEXPrintOrdChange/TPCXbody/TPCXitem/fabricComponent/refDoc/attachment/externalReference/mimeCode) 0-1 (XPath TEXPrintOrdChange/TPCXheader/refDoc/attachment/externalReference/mimeCode) 0-1</p>
@minQty	<p>minimum product quantity</p> <p>- base type: decimal, min inclusive: 0, fraction digits: 2, (XPath TEXPrintOrdChange/terms/allowanceCharge/@minQty) [Optional]</p> <p>- nota: <i>minimum quantity of product for the application of this allowance or charge</i></p>
mixMatch	<p>colour hue used for the match of garments</p> <p>- base type: string, max length: 15, (XPath TEXPrintOrdChange/TPCXbody/TPCXitem/fabricProd/piece/mixMatch) 0-1</p>
msgCurrency	<p>currency used to express the monetary amounts of the message</p> <p>- base type: string, cod. table: T9 http://www.ebiz.enea.it/moda-ml/repository/codelist/draft/gc_T9.xml (XPath TEXPrintOrdChange/TPCXheader/msgCurrency) 0-1</p>

msgDate	date of issue of the present message (xml document), according to one of the patterns YYYY-MM-DD, YYYY-MM-DD:HH-MM or YYYY-WW. - base type: string, (XPath TEXPrintOrdChange/TPCXheader/msgDate) 1-1
@msgfunction	function performed by the present message with regards to the transmission - base type: string, cod. table: NT18 http://www.ebiz.enea.it/moda-ml/repository/codelist/draft/gc_NT18.xml (XPath TEXPrintOrdChange/@msgfunction) [Optional]
msgID	key identifier of the business document in the information system of the issuing Party. In case of more despatches of the same business document, it is unchanged. - base type: string, max length: 35, (XPath TEXPrintOrdChange/TPCXheader/msgID) 0-1
msgN	identification number given to the message (xml document) by its issuer. In case of more despatches of the same business document, it changes. - base type: string, max length: 35, (XPath TEXPrintOrdChange/TPCXheader/msgN) 1-1
netWeight	the net weight declared for transport or customs purpose - base type: decimal, min inclusive: 0, fraction digits: 2, (XPath TEXPrintOrdChange/terms/transInfo/netWeight) 0-1
note	free text or structured (computer processing) note. For note structuring use the attributes "noteLabel" and "codelist" - base type: string, max length: 350, (XPath TEXPrintOrdChange/TPCXbody/TPCXitem/fabricProd/note) 0-99 (XPath TEXPrintOrdChange/TPCXbody/TPCXitem/fabPrintOperation/note) 0-99 (XPath TEXPrintOrdChange/TPCXheader/note) 0-99 (XPath TEXPrintOrdChange/TPCXbody/TPCXitem/fabricComponent/note) 0-99 (XPath TEXPrintOrdChange/TPCXbody/TPCXitem/dtScheme/note) 0-99 (XPath TEXPrintOrdChange/terms/allowanceCharge/dtScheme/note) 0-99
@noteLabel	subject qualifier of a note - base type: string, max length: 35, (XPath TEXPrintOrdChange/TPCXbody/TPCXitem/fabricProd/note/@noteLabel) [Optional] - nota: <i>must be used to qualify the subject of the note</i> (XPath TEXPrintOrdChange/terms/allowanceCharge/dtScheme/note/@noteLabel) [Optional] - nota: <i>must be used to qualify the subject of the note</i> (XPath TEXPrintOrdChange/TPCXbody/TPCXitem/fabricComponent/note/@noteLabel) [Optional] - nota: <i>must be used to qualify the subject of the note</i> (XPath TEXPrintOrdChange/TPCXbody/TPCXitem/fabPrintOperation/note/@noteLabel) [Optional] - nota: <i>must be used to qualify the subject of the note</i> (XPath TEXPrintOrdChange/TPCXbody/TPCXitem/dtScheme/note/@noteLabel) [Optional] - nota: <i>must be used to qualify the subject of the note</i> (XPath TEXPrintOrdChange/TPCXheader/note/@noteLabel) [Optional] - nota: <i>must be used to qualify the subject of the note</i>
@numberingOrg	code specifying the organisation who has created or owns the coding or numbering system - base type: string, cod. table: NT6 http://www.ebiz.enea.it/moda-ml/repository/codelist/draft/gc_NT6.xml (XPath TEXPrintOrdChange/TPCXheader/refDoc/season/@numberingOrg) [Optional]

(XPath TEXPrintOrdChange/TPCXbody/TPCXitem/fabricProd/piece/mixMatch/@numberingOrg) [Optional]

(XPath TEXPrintOrdChange/TPCXbody/TPCXitem/fabricProd/piece/packageN/@numberingOrg) [Optional]

(XPath TEXPrintOrdChange/TPCXbody/TPCXitem/fabricComponent/note/@numberingOrg) [Optional]

(XPath TEXPrintOrdChange/TPCXbody/TPCXitem/fabricComponent/itemsList/qualityLevel/@numberingOrg) [Optional]

(XPath TEXPrintOrdChange/TPCXbody/TPCXitem/dtScheme/note/@numberingOrg) [Optional]

(XPath TEXPrintOrdChange/TPCXbody/TPCXitem/fabricProd/texCode/color/@numberingOrg) [Optional]

- nota: *this attribute should be used either single or coupled with "listName" and "listVersion"*

(XPath TEXPrintOrdChange/TPCXbody/TPCXitem/fabricProd/texCode/@numberingOrg) [Optional]

(XPath TEXPrintOrdChange/TPCXbody/TPCXitem/fabricComponent/texCode/added/@numberingOrg) [Optional]

(XPath TEXPrintOrdChange/terms/allowanceCharge/dtScheme/note/@numberingOrg) [Optional]

(XPath TEXPrintOrdChange/TPCXheader/thirdParty/id/@numberingOrg) [Optional]

(XPath TEXPrintOrdChange/TPCXbody/TPCXitem/thirdParty/id/@numberingOrg) [Optional]

(XPath TEXPrintOrdChange/TPCXheader/note/@numberingOrg) [Optional]

(XPath TEXPrintOrdChange/TPCXheader/docID/@numberingOrg) [Optional]

- nota: *here can be specified whose document numbering is used (e.g.: Client, Supplier, ..)*

(XPath TEXPrintOrdChange/TPCXbody/TPCXitem/fabricProd/texCode/pattern/@numberingOrg) [Optional]

- nota: *this attribute should be used either single or coupled with "listName" and "listVersion"*

(XPath TEXPrintOrdChange/TPCXbody/TPCXitem/fabricProd/note/@numberingOrg) [Optional]

(XPath TEXPrintOrdChange/TPCXbody/TPCXitem/fabricProd/texCode/art/@numberingOrg) [Optional]

- nota: *this attribute should be used either single or coupled with "listName" and "listVersion"*

(XPath TEXPrintOrdChange/TPCXbody/TPCXitem/fabPrintOperation/refDoc/docID/@numberingOrg) [Optional]

- nota: *here can be specified whose document numbering is used (e.g.: Client, Supplier, ..)*

(XPath TEXPrintOrdChange/TPCXbody/TPCXitem/fabricComponent/serialN/@numberingOrg) [Optional]

- nota: *here the issuer of the serial number must be specified (when different from the Supplier)*

(XPath TEXPrintOrdChange/TPCXbody/TPCXitem/fabPrintOperation/refDoc/attachment/fileName/@numberingOrg) [Optional]

(XPath TEXPrintOrdChange/TPCXbody/TPCXitem/fabricProd/pieceChain/serialN/@numberingOrg) [Optional]

- nota: *here the issuer of the serial number must be specified (when different from the Supplier)*

(XPath TEXPrintOrdChange/TPCXbody/TPCXitem/fabricProd/pieceChain/pieceCut/serialN/@numberingOrg) [Optional]

- nota: *here the issuer of the serial number must be specified (when different from the Supplier)*

(XPath TEXPrintOrdChange/TPCXbody/TPCXitem/refDoc/docID/@numberingOrg) [Optional]

- nota: *here can be specified whose document numbering is used (e.g.: Client, Supplier, ..)*

(XPath
 TEXTPrintOrdChange/TPCXbody/TPCXitem/fabPrintOperation/note/@numberingOrg) [Optional]

(XPath TEXTPrintOrdChange/TPCXbody/TPCXitem/fabricProd/piece/serialN/@numberingOrg) [Optional]

- nota: *here the issuer of the serial number must be specified (when different from the Supplier)*

(XPath
 TEXTPrintOrdChange/TPCXbody/TPCXitem/fabricComponent/refDoc/docID/@numberingOrg) [Optional]

- nota: *here can be specified whose document numbering is used (e.g.: Client, Supplier, ..)*

(XPath
 TEXTPrintOrdChange/TPCXbody/TPCXitem/fabricComponent/refDoc/season/@numberingOrg) [Optional]

(XPath TEXTPrintOrdChange/TPCXheader/refDoc/docID/@numberingOrg) [Optional]

- nota: *here can be specified whose document numbering is used (e.g.: Client, Supplier, ..)*

(XPath TEXTPrintOrdChange/TPCXbody/TPCXitem/fabricProd/pieceChain/dyeN/@numberingOrg) [Optional]

(XPath TEXTPrintOrdChange/TPCXbody/TPCXitem/fabricProd/pieceChain/lotN/@numberingOrg) [Optional]

(XPath TEXTPrintOrdChange/TPCXbody/TPCXitem/fabricProd/pieceChain/packageN/@numberingOrg) [Optional]

(XPath
 TEXTPrintOrdChange/TPCXbody/TPCXitem/fabricComponent/refDoc/attachment/fileName/@numberingOrg) [Optional]

(XPath TEXTPrintOrdChange/TPCXheader/season/@numberingOrg) [Optional]

(XPath
 TEXTPrintOrdChange/TPCXbody/TPCXitem/fabricComponent/texCode/color/@numberingOrg) [Optional]

- nota: *this attribute should be used either single or coupled with "listName" and "listVersion"*

(XPath TEXTPrintOrdChange/TPCXbody/TPCXitem/fabricProd/piece/EPC/@numberingOrg) [Optional]

(XPath TEXTPrintOrdChange/TPCXbody/TPCXitem/refDoc/attachment/fileName/@numberingOrg) [Optional]

(XPath
 TEXTPrintOrdChange/TPCXbody/TPCXitem/fabricComponent/texCode/art/@numberingOrg) [Optional]

- nota: *this attribute should be used either single or coupled with "listName" and "listVersion"*

(XPath TEXTPrintOrdChange/TPCXheader/buyer/id/@numberingOrg) [Optional]

(XPath
 TEXTPrintOrdChange/TPCXheader/buyer/additionalIdentifier/@numberingOrg) [Optional]

- nota: *here the issuer of the identifier must be specified*

(XPath TEXTPrintOrdChange/TPCXbody/TPCXitem/fabricProd/piece/dyeN/@numberingOrg) [Optional]

(XPath
 TEXTPrintOrdChange/TPCXbody/TPCXitem/fabricComponent/texCode/@numberingOrg) [Optional]

(XPath TEXTPrintOrdChange/TPCXbody/TPCXitem/fabricProd/piece/lotN/@numberingOrg) [Optional]

(XPath TEXTPrintOrdChange/TPCXbody/TPCXitem/fabricProd/texCode/added/@numberingOrg) [Optional]

(XPath TEXTPrintOrdChange/TPCXheader/subContractor/id/@numberingOrg) [Optional]

(XPath
 TEXTPrintOrdChange/TPCXbody/TPCXitem/fabPrintOperation/groundColor/@numberingOrg) [Optional]

(XPath TEXTPrintOrdChange/TPCXheader/refDoc/attachment/fileName/@numberingOrg) [Optional]

(XPath
 TEXTPrintOrdChange/TPCXbody/TPCXitem/fabricComponent/texCode/pattern/@numberingOrg) [Optional]

	<p>- nota: <i>this attribute should be used either single or coupled with "listName" and "listVersion"</i></p> <p>(XPath TEXPrintOrdChange/TPCXbody/TPCXitem/fabPrintOperation/refDoc/season/ /@numberingOrg) [Optional] (XPath TEXPrintOrdChange/TPCXbody/TPCXitem/refDoc/season/@numberingOrg) [Optional] (XPath TEXPrintOrdChange/TPCXbody/TPCXitem/fabricComponent/itemsList/itemI dentification/serialN/@numberingOrg) [Optional]</p> <p>- nota: <i>here the issuer of the serial number must be specified (when differen t from the Supplier)</i></p>
@packageContainerN	<p>reference usable to indicate the outer package containing this package</p> <p>- base type: string, max length: 40, (XPath TEXPrintOrdChange/TPCXbody/TPCXitem/fabricProd/ pieceChain/packageN/@packageContainerN) [Optional] (XPath TEXPrintOrdChange/TPCXbody/TPCXitem/fabricProd/ piece/packageN/@packageContainerN) [Optional]</p>
packageN	<p>serial number used to identify a transport package</p> <p>- base type: string, max length: 40, (XPath TEXPrintOrdChange/TPCXbody/TPCXitem/fabricProd/ piece/packageN) 0-1</p> <p>- note: <i>here the transport package containing the piece can be identified</i> (XPath TEXPrintOrdChange/TPCXbody/TPCXitem/fabricProd/ pieceChain/packageN) 0-1</p>
@part	<p>percent fraction of a total payment</p> <p>- base type: decimal, min inclusive: 1, max inclusive: 99, fraction digits: 2, (XPath TEXPrintOrdChange/terms/insPayment/@part) [Required]</p> <p>- nota: <i>here the % value of each installment must be indicated</i></p>
pattern	<p>pattern/design number of the product, when not included in the article code</p> <p>- base type: string, max length: 15, (XPath TEXPrintOrdChange/TPCXbody/TPCXitem/fabricComponent/texCode/patter n) 0-1 (XPath TEXPrintOrdChange/TPCXbody/TPCXitem/fabricProd/ texCode/pattern) 0-1</p>
payMode	<p>way or means of payment</p> <p>- base type: string, cod. table: T2 http://www.ebiz.enea.it/moda-ml/repository/codelist/draft/gc_T2.xml (XPath TEXPrintOrdChange/terms/insPayment/payMode) 0-1 (XPath TEXPrintOrdChange/terms/payment/payMode) 0-1</p>
payTerm	<p>code specifying the terms or time by which the payment must be done</p> <p>- base type: string, cod. table: T1 http://www.ebiz.enea.it/moda-ml/repository/codelist/draft/gc_T1.xml (XPath TEXPrintOrdChange/terms/payment/payTerm) 1-1 (XPath TEXPrintOrdChange/terms/insPayment/payTerm) 1-1</p>
payTermText	<p>free text specifying the terms by which the payment must be done (time/mo de or means)</p> <p>- base type: string, max length: 250, (XPath TEXPrintOrdChange/terms/insPayment/payTermText) 1-1 (XPath TEXPrintOrdChange/terms/payment/payTermText) 1-1</p>
pcTolerance	<p>percent deviation tolerated on the value of a measurement (it must have a pl us or minus sign)</p> <p>- base type: decimal, min inclusive: 0, max inclusive: 100, total digits: 2, (XPath TEXPrintOrdChange/TPCXbody/TPCXitem/fabricProd/ fabricSpecs/pcTolerance) 0-2</p>
percCompos	<p>fiber rate in the product composition</p> <p>- base type: decimal, min inclusive: 0, max inclusive: 100, fraction digits: 2,</p>

	(XPath TEXPrintOrdChange/TPCXbody/TPCXitem/fabricProd/fabricCompos/percCompos) 1-9
person	name of the contact person within a Party - base type: string, max length: 40, (XPath TEXPrintOrdChange/TPCXbody/TPCXitem/thirdParty/person) 0-1 (XPath TEXPrintOrdChange/TPCXheader/thirdParty/person) 0-1 (XPath TEXPrintOrdChange/TPCXheader/buyer/person) 0-1 (XPath TEXPrintOrdChange/TPCXheader/subContractor/person) 0-1
@phone	phone number of the contact person within a Party - base type: string, max length: 35, (XPath TEXPrintOrdChange/TPCXheader/subContractor/person/@phone) [Optional] (XPath TEXPrintOrdChange/TPCXheader/buyer/person/@phone) [Optional] (XPath TEXPrintOrdChange/TPCXheader/thirdParty/person/@phone) [Optional] (XPath TEXPrintOrdChange/TPCXbody/TPCXitem/thirdParty/person/@phone) [Optional]
pieceAllow	allowance required or accorded for the piece - base type: decimal, fraction digits: 2, (XPath TEXPrintOrdChange/TPCXbody/TPCXitem/fabricProd/piece/pieceAllow) 0-1
pieceCutWidth	effective usable width of the fabric piece (for garment manufacturing) - base type: decimal, min inclusive: 0, fraction digits: 2, (XPath TEXPrintOrdChange/TPCXbody/TPCXitem/fabricProd/piece/pieceCutWidth) 0-1
pieceInnWrap1	code specifying the type of inner wrapping/packing used for the fabric piece - base type: string, cod. table: T4 http://www.ebiz.enea.it/moda-ml/repository/codelist/draft/gc_T4.xml (XPath TEXPrintOrdChange/TPCXbody/TPCXitem/fabricProd/pieceChain/piecePack/pieceInnWrap1) 1-1 (XPath TEXPrintOrdChange/TPCXbody/TPCXitem/fabricProd/piece/piecePack/pieceInnWrap1) 1-1
pieceInnWrap2	code sub-specifying the type of inner wrapping/packing used for the fabric piece - base type: string, cod. table: T5 http://www.ebiz.enea.it/moda-ml/repository/codelist/draft/gc_T5.xml (XPath TEXPrintOrdChange/TPCXbody/TPCXitem/fabricProd/pieceChain/piecePack/pieceInnWrap2) 0-1 (XPath TEXPrintOrdChange/TPCXbody/TPCXitem/fabricProd/piece/piecePack/pieceInnWrap2) 0-1
pieceLength	length of the piece - base type: decimal, min inclusive: 0, fraction digits: 2, (XPath TEXPrintOrdChange/TPCXbody/TPCXitem/fabricProd/piece/pieceLength) 0-1 (XPath TEXPrintOrdChange/TPCXbody/TPCXitem/fabricProd/pieceChain/pieceLength) 0-1 (XPath TEXPrintOrdChange/TPCXbody/TPCXitem/fabricProd/pieceChain/pieceCut/pieceLength) 0-1
pieceOutWrap	code specifying the type of outer wrapping or packing used for the fabric piece - base type: string, cod. table: T6 http://www.ebiz.enea.it/moda-ml/repository/codelist/draft/gc_T6.xml (XPath TEXPrintOrdChange/TPCXbody/TPCXitem/fabricProd/piece/piecePack/pieceOutWrap) 0-1 (XPath TEXPrintOrdChange/TPCXbody/TPCXitem/fabricProd/pieceChain/piecePack/pieceOutWrap) 0-1
piecePackText	free text specifying the type of wrapping or packing used for the fabric piece - base type: string, max length: 250, (XPath TEXPrintOrdChange/TPCXbody/TPCXitem/fabricProd/piece/piecePack/piecePackText) 1-1

	(XPath TEXPrintOrdChange/TPCXbody/TPCXitem/fabricProd/pieceChain/piecePack/piecePackText) 1-1
pieceStatus	code used to describe the status of a fabric piece after the control - base type: string, cod. table: T52 http://www.ebiz.enea.it/moda-ml/repository/codelist/draft/gc_T52.xml (XPath TEXPrintOrdChange/TPCXbody/TPCXitem/fabricProd/piece/pieceStatus) 0-1
pieceWeight	effective total weight of the fabric piece - base type: decimal, min inclusive: 0, fraction digits: 2, (XPath TEXPrintOrdChange/TPCXbody/TPCXitem/fabricProd/piece/pieceWeight) 0-1 - note: <i>It is the net weight of the piece.</i> (XPath TEXPrintOrdChange/TPCXbody/TPCXitem/fabricProd/pieceChain/pieceWeight) 0-1 (XPath TEXPrintOrdChange/TPCXbody/TPCXitem/fabricProd/pieceChain/pieceCut/pieceWeight) 0-1
pieceWeightM	effective weight per metre of the fabric piece - base type: decimal, min inclusive: 0, fraction digits: 2, (XPath TEXPrintOrdChange/TPCXbody/TPCXitem/fabricProd/piece/pieceWeightM) 0-1
pieceWidth	effective width of the fabric piece - base type: decimal, min inclusive: 0, fraction digits: 2, (XPath TEXPrintOrdChange/TPCXbody/TPCXitem/fabricProd/piece/pieceWidth) 0-1 (XPath TEXPrintOrdChange/TPCXbody/TPCXitem/fabricProd/pieceChain/pieceWidth) 0-1
postCode	code defining the postal zone - base type: string, max length: 10, (XPath TEXPrintOrdChange/TPCXheader/buyer/postCode) 0-1 (XPath TEXPrintOrdChange/TPCXbody/TPCXitem/thirdParty/postCode) 0-1 (XPath TEXPrintOrdChange/TPCXheader/subContractor/postCode) 0-1 (XPath TEXPrintOrdChange/TPCXheader/thirdParty/postCode) 0-1
price	unit price of the article, object or service specified - base type: decimal, min inclusive: 0, fraction digits: 4, (XPath TEXPrintOrdChange/TPCXbody/TPCXitem/price) 0-1
@priceQualifier	type of price with reference to discount and taxes - base type: string, cod. table: NT20 http://www.ebiz.enea.it/moda-ml/repository/codelist/draft/gc_NT20.xml (XPath TEXPrintOrdChange/TPCXbody/TPCXitem/price/@priceQualifier) [Optional] [Default= NET]
@productLevel	level of the product (end or intermediate) yielded by an operation in a work cycle - base type: string, cod. table: NT22 http://www.ebiz.enea.it/moda-ml/repository/codelist/draft/gc_NT22.xml (XPath TEXPrintOrdChange/TPCXbody/TPCXitem/@productLevel) [Optional] [Default= END] - nota: <i>this qualifier "intermediate" must be used when the product is also a component in an other line of the same Commission Order</i>
@progr	progressive number in the sequence - base type: positiveInteger, min inclusive: 1, (XPath TEXPrintOrdChange/terms/transInfo/@progr) [Optional] - nota: <i>Indicates the position of the leg in a sequence of transport legs.</i>
qty	net quantity of the article or object correlated, qualified by the function of the document (ordering, delivering, ..) and by the context - base type: decimal, min inclusive: 0, fraction digits: 2, (XPath TEXPrintOrdChange/TPCXbody/TPCXitem/qty) 0-3

	<p>(XPath TEXPrintOrdChange/TPCXbody/TPCXitem/fabricComponent/qty) 1-3 - note: <i>quantity to be consumed in the transformation. This element can have more instances only if the units of measure are different</i></p>
qualityLevel	<p>the product quality level (first choice, second choice,...). - base type: string, (XPath TEXPrintOrdChange/TPCXbody/TPCXitem/fabricComponent/itemsList/qualityLevel) 0-1</p>
@role	<p>Third Party role qualifier - base type: string, cod. table: NT2 http://www.ebiz.enea.it/moda-ml/repository/codelist/draft/gc_NT2.xml (XPath TEXPrintOrdChange/TPCXheader/thirdParty/@role) [Required] (XPath TEXPrintOrdChange/TPCXbody/TPCXitem/thirdParty/@role) [Required]</p>
@screenN	<p>identification number of a printing screen - base type: positiveInteger, (XPath TEXPrintOrdChange/TPCXbody/TPCXitem/fabPrintOperation/groundColor/@screenN) [Required]</p>
season	<p>sale season; defined as: season (1 crt) + year (4 crt) - season: S/S=1 A/W=2 Spring=3 Summer=4 Autumn=5 Winter=6: for more than four seasons use alphabetic sequence: 1st season=A 2nd season=B etc.etc. - base type: string, max length: 15, (XPath TEXPrintOrdChange/TPCXbody/TPCXitem/refDoc/season) 0-1 - note: <i>here indicates the season to which the referenced document belongs</i> (XPath TEXPrintOrdChange/TPCXheader/season) 0-1 (XPath TEXPrintOrdChange/TPCXheader/refDoc/season) 0-1 - note: <i>here indicates the season to which the referenced document belongs</i> (XPath TEXPrintOrdChange/TPCXbody/TPCXitem/fabPrintOperation/refDoc/season)) 0-1 - note: <i>here indicates the season to which the referenced document belongs</i> (XPath TEXPrintOrdChange/TPCXbody/TPCXitem/fabricComponent/refDoc/season) 0-1 - note: <i>here indicates the season to which the referenced document belongs</i></p>
@sender	<p>qualifier that specifies the Party issuing of the document - base type: boolean, (XPath TEXPrintOrdChange/TPCXheader/buyer/@sender) [Optional] - nota: <i>This attribute is mandatory when the STYLESHEET must be used</i> (XPath TEXPrintOrdChange/TPCXheader/subContractor/@sender) [Optional] - nota: <i>This attribute is mandatory when the STYLESHEET must be used</i> (XPath TEXPrintOrdChange/TPCXheader/thirdParty/@sender) [Optional] - nota: <i>This attribute is mandatory when the STYLESHEET must be used</i> (XPath TEXPrintOrdChange/TPCXbody/TPCXitem/thirdParty/@sender) [Optional] - nota: <i>This attribute is mandatory when the STYLESHEET must be used</i></p>
serialN	<p>serial number used for the identification of a physical unit - base type: string, max length: 250, (XPath TEXPrintOrdChange/TPCXbody/TPCXitem/fabricComponent/itemsList/itemIdentification/serialN) 1-9</p> <hr/> <p>AAAA-WARNING! - text not AVAILABLE n. 245 - In=en - note: <i>multiple values of serialN are allowed for different representations of the serial identifier of the same product unit. Instances of serialN must differ at least for one value of numberingOrg and idQualifier.</i> (XPath TEXPrintOrdChange/TPCXbody/TPCXitem/fabricProd/pieceChain/serialN) 1-9 - note: <i>multiple values of serialN are allowed in order to provide different representations of the serial identifier of the same piece chain. Different instances of serialN must differ at least for one value of idQualifier or numberingOrg</i></p>

	<p>(XPath TEXPrintOrdChange/TPCXbody/TPCXitem/fabricComponent/serialN) 0- unbounded - note: <i>it may be used to identify the pieces/chains that the Subcontractor must use for the commissioned work</i> (XPath TEXPrintOrdChange/TPCXbody/TPCXitem/fabricProd/ piece/serialN) 0-9</p> <hr/> <p>AAAA-WARNING! - text not AVAILABLE n. 245 - In=en - note: <i>multiple values of serialN are allowed for different representations of the serial identifier of the same piece. Instances of serialN must differ at least for one value of numberingOrg and idQualifier.</i> (XPath TEXPrintOrdChange/TPCXbody/TPCXitem/fabricProd/ pieceChain/pieceCut/serialN) 1-9 - note: <i>multiple values of serialN are allowed in order to provide different representations of the serial identifier of the same piece. Different instances of serialN must differ at least for one value of idQualifier or numberingOrg</i></p>
@source	<p>party who has provided the data - base type: string, cod. table: NT12 http://www.ebiz.enea.it/moda-ml/repository/codelist/draft/gc_NT12.xml (XPath TEXPrintOrdChange/TPCXbody/TPCXitem/fabPrintOperation/fabPrintSpecs/ specValue/@source) [Optional] (XPath TEXPrintOrdChange/TPCXbody/TPCXitem/fabricProd/ fabricSpecs/specValue/@source) [Optional]</p>
specValue	<p>value requested for a property or a parameter that is measured - base type: decimal, (XPath TEXPrintOrdChange/TPCXbody/TPCXitem/fabPrintOperation/fabPrintSpecs/ specValue) 0-1 (XPath TEXPrintOrdChange/TPCXbody/TPCXitem/fabricProd/ fabricSpecs/specValue) 0-1</p>
street	<p>street and building number identifying a location - base type: string, max length: 80, (XPath TEXPrintOrdChange/TPCXheader/subContractor/street) 0-1 (XPath TEXPrintOrdChange/TPCXheader/buyer/street) 0-1 (XPath TEXPrintOrdChange/TPCXheader/thirdParty/street) 0-1 (XPath TEXPrintOrdChange/TPCXbody/TPCXitem/thirdParty/street) 0-1</p>
subCountry	<p>short name or code of the sub-country entity - base type: string, max length: 9, (XPath TEXPrintOrdChange/TPCXbody/TPCXitem/thirdParty/subCountry) 0-1 (XPath TEXPrintOrdChange/TPCXheader/subContractor/subCountry) 0-1 (XPath TEXPrintOrdChange/TPCXheader/thirdParty/subCountry) 0-1 (XPath TEXPrintOrdChange/TPCXheader/buyer/subCountry) 0-1</p>
subDept	<p>name or code of a contact department within a Party - base type: string, max length: 40, (XPath TEXPrintOrdChange/TPCXheader/subContractor/subDept) 0-1 (XPath TEXPrintOrdChange/TPCXheader/buyer/subDept) 0-1 (XPath TEXPrintOrdChange/TPCXbody/TPCXitem/thirdParty/subDept) 0-1 (XPath TEXPrintOrdChange/TPCXheader/thirdParty/subDept) 0-1</p>
taxCategory	<p>duty or tax or fee category - base type: string, cod. table: T62 http://www.ebiz.enea.it/moda-ml/repository/codelist/draft/gc_T62.xml (XPath TEXPrintOrdChange/terms/allowanceCharge/dtScheme/taxCategory) 0-1 (XPath TEXPrintOrdChange/TPCXbody/TPCXitem/dtScheme/taxCategory) 0-1</p>
taxRate	<p>duty or tax or fee percent rate - base type: string, (XPath TEXPrintOrdChange/terms/allowanceCharge/dtScheme/taxRate) 0-1 (XPath TEXPrintOrdChange/TPCXbody/TPCXitem/dtScheme/taxRate) 0-1</p>
@taxType	<p>duty or tax or fee type - base type: string, cod. table: T61 http://www.ebiz.enea.it/moda-ml/repository/codelist/draft/gc_T61.xml</p>

	(XPath TEXPrintOrdChange/terms/allowanceCharge/dtScheme/@taxType) [Required] (XPath TEXPrintOrdChange/TPCXbody/TPCXitem/dtScheme/@taxType) [Required]
@TID	serial number wired into the RFID chip - base type: string, (XPath TEXPrintOrdChange/TPCXbody/TPCXitem/fabricProd/piece/EPC/@TID) [Optional]
tolerance	deviation tolerated on the value of a measurement (it must have a plus or minus sign) - base type: decimal, (XPath TEXPrintOrdChange/TPCXbody/TPCXitem/fabricProd/fabricSpecs/tolerance) 0-2
totFault	total number of faults: the 1st/2nd digit count the "Large faults", the 3rd/4th the "Medium faults" and the 5th/6th the "Small faults" - base type: positiveInteger, (XPath TEXPrintOrdChange/TPCXbody/TPCXitem/fabricProd/piece/totFault) 0-1
transCondition	special condition of transport or special service requested to the Forwarder - base type: string, cod. table: T38 http://www.ebiz.enea.it/moda-ml/repository/codelist/draft/gc_T38.xml (XPath TEXPrintOrdChange/terms/transInfo/transCondition) 0-3
transConditionText	free text description of the special condition of transport or special service requested to the Forwarder - base type: string, max length: 250, (XPath TEXPrintOrdChange/terms/transInfo/transConditionText) 0-1
transMeans	means of transport, in general or referred to a specific leg - base type: string, cod. table: T40 http://www.ebiz.enea.it/moda-ml/repository/codelist/draft/gc_T40.xml (XPath TEXPrintOrdChange/terms/transInfo/transMeans) 0-1
transMode	way of transport, in general or referred to the specified leg - base type: string, cod. table: T8 http://www.ebiz.enea.it/moda-ml/repository/codelist/draft/gc_T8.xml (XPath TEXPrintOrdChange/terms/transInfo/transMode) 1-1
@transReason	reason for the transport - base type: string, cod. table: NT11 http://www.ebiz.enea.it/moda-ml/repository/codelist/draft/gc_NT11.xml (XPath TEXPrintOrdChange/terms/transInfo/@transReason) [Optional]
@uid	unique element identifier within the xml document - base type: string, (XPath TEXPrintOrdChange/TPCXbody/TPCXitem/fabPrintOperation/refDoc/attachment/@uid) [Optional] (XPath TEXPrintOrdChange/TPCXbody/TPCXitem/refDoc/attachment/@uid) [Optional] (XPath TEXPrintOrdChange/TPCXheader/refDoc/attachment/@uid) [Optional] (XPath TEXPrintOrdChange/TPCXbody/TPCXitem/fabricComponent/refDoc/attachment/@uid) [Optional]
@um	specification of the unit of measure - base type: string, cod. table: NT7 http://www.ebiz.enea.it/moda-ml/repository/codelist/draft/gc_NT7.xml (XPath TEXPrintOrdChange/TPCXbody/TPCXitem/fabricProd/pieceChain/pieceLength/@um) [Optional] [Default= MTR] (XPath TEXPrintOrdChange/TPCXbody/TPCXitem/fabricProd/fabricSpecs/pcTolerance/@um) [Optional] - nota: <i>to be used when it has to be soecified if the declared percentage is by weight, volume, etc...</i>

	<p>(XPath <code>TEXPrintOrdChange/TPCXbody/TPCXitem/fabricProd/fabricSpecs/tolerance/@um</code>) [Required]</p> <p>(XPath <code>TEXPrintOrdChange/terms/transInfo/netWeight/@um</code>) [Required]</p> <p>(XPath <code>TEXPrintOrdChange/terms/transInfo/grossWeight/@um</code>) [Required]</p> <p>(XPath <code>TEXPrintOrdChange/terms/allowanceCharge/@um</code>) [Optional]</p> <p>(XPath <code>TEXPrintOrdChange/TPCXbody/TPCXitem/fabricProd/fabricSpecs/specValue/@um</code>) [Optional]</p> <p>(XPath <code>TEXPrintOrdChange/TPCXbody/TPCXitem/fabricProd/fabricWidth/@um</code>) [Optional] [Default= CMT]</p> <p>(XPath <code>TEXPrintOrdChange/TPCXbody/TPCXitem/fabricProd/pieceChain/pieceWidth/@um</code>) [Optional] [Default= CMT]</p> <p>(XPath <code>TEXPrintOrdChange/TPCXbody/TPCXitem/fabricProd/piece/grossWeight/@um</code>) [Required]</p> <p>(XPath <code>TEXPrintOrdChange/TPCXbody/TPCXitem/fabricProd/piece/pieceAllow/@um</code>) [Required]</p> <p>(XPath <code>TEXPrintOrdChange/TPCXbody/TPCXitem/fabricProd/piece/pieceWeight/@um</code>) [Optional] [Default= KGM]</p> <p>(XPath <code>TEXPrintOrdChange/TPCXbody/TPCXitem/fabricProd/piece/pieceWeightM/@um</code>) [Optional] [Default= GRM]</p> <p>(XPath <code>TEXPrintOrdChange/TPCXbody/TPCXitem/fabricComponent/qty/@um</code>) [Required]</p> <p>(XPath <code>TEXPrintOrdChange/TPCXbody/TPCXitem/fabPrintOperation/fabPrintSpecs/specValue/@um</code>) [Optional]</p> <p>(XPath <code>TEXPrintOrdChange/TPCXbody/TPCXitem/qty/@um</code>) [Required]</p> <p>(XPath <code>TEXPrintOrdChange/TPCXbody/TPCXitem/price/@um</code>) [Optional]</p> <p>- nota: <i>Unit of measure of the product to which the price is referred (price per meter)</i></p> <p>(XPath <code>TEXPrintOrdChange/TPCXbody/TPCXitem/fabricProd/pieceChain/pieceCut/pieceWeight/@um</code>) [Optional] [Default= KGM]</p> <p>(XPath <code>TEXPrintOrdChange/TPCXbody/TPCXitem/fabricProd/piece/pieceLength/@um</code>) [Optional] [Default= MTR]</p> <p>(XPath <code>TEXPrintOrdChange/TPCXbody/TPCXitem/fabricProd/pieceChain/pieceWeight/@um</code>) [Optional] [Default= KGM]</p> <p>(XPath <code>TEXPrintOrdChange/TPCXbody/TPCXitem/fabricProd/pieceChain/pieceCut/pieceLength/@um</code>) [Optional] [Default= MTR]</p> <p>(XPath <code>TEXPrintOrdChange/TPCXbody/TPCXitem/fabricProd/piece/pieceWidth/@um</code>) [Optional] [Default= CMT]</p> <p>(XPath <code>TEXPrintOrdChange/TPCXbody/TPCXitem/fabricProd/piece/pieceCutWidth/@um</code>) [Optional] [Default= CMT]</p>
uri	<p>Uniform Resource Identifier (URI) that identifies the external object as an Internet resource</p> <p>- base type: normalizedString,</p> <p>(XPath <code>TEXPrintOrdChange/TPCXbody/TPCXitem/fabricComponent/refDoc/attachment/externalReference/uri</code>) 1-1</p> <p>(XPath <code>TEXPrintOrdChange/TPCXheader/refDoc/attachment/externalReference/uri</code>) 1-1</p> <p>(XPath <code>TEXPrintOrdChange/TPCXbody/TPCXitem/refDoc/attachment/externalReference/uri</code>) 1-1</p> <p>(XPath <code>TEXPrintOrdChange/TPCXbody/TPCXitem/fabPrintOperation/refDoc/attachment/externalReference/uri</code>) 1-1</p>
@useProfile	<p>use profile to which the present document is compliant if it was agreed by the parties. It is suggested a URI with reference to the firms or the URL of the profile.</p> <p>- base type: string,</p> <p>(XPath <code>TEXPrintOrdChange/@useProfile</code>) [Optional]</p>
@VAT	<p>VAT rate or code (DEPRECATED, use dtScheme element)</p> <p>- base type: string, cod. table: NT16</p> <p>http://www.ebiz.enea.it/moda-ml/repository/codelist/draft/gc_NT16.xml</p> <p>(XPath <code>TEXPrintOrdChange/terms/allowanceCharge/@VAT</code>) [Optional]</p> <p>(XPath <code>TEXPrintOrdChange/TPCXbody/TPCXitem/lineN/@VAT</code>) [Optional]</p>

	<p>- nota: <i>Deprecated, prefer dtScheme when available.</i></p> <p>(XPath <code>TEXPrintOrdChange/TPCXbody/TPCXitem/thirdParty/@VAT</code>) [Optional]</p> <p>(XPath <code>TEXPrintOrdChange/TPCXheader/thirdParty/@VAT</code>) [Optional]</p>
@version	<p>Dictionary version from which the instance has been created</p> <p>- base type: string, cod. table: NT100</p> <p>http://www.ebiz.enea.it/moda-ml/repository/codelist/draft/gc_NT100.xml</p> <p>(XPath <code>TEXPrintOrdChange/@version</code>) [Optional] [Default= draft]</p>

2.3 Suggested best practices

TEXPrintOrdChange/TPCXbody/TPCXitem/fabricComponent/itemsList/itemIdentification/serialN (serial number used for the identification of a physical unit)

in the case of garment with RFID for anti-counterfeiting, RFID EPCGlobal for logistics and NFC for the customer experience there should be three serial elements with pairs of attributes numberingOrg/idQualifier: "CL"/"RFID", "GS1"/"RFID", "CL"/"NFC".

TEXPrintOrdChange/TPCXbody/TPCXitem/fabricProd/
piece/serialN (serial number used for the identification of a physical unit)

This element might contain also codes for RFID devices.

2.4 Enumeration tables

List of enumeration tables used in the XML document. You can find the corresponding codes at:
<http://www.ebiz-tcf.eu/moda-ml/imple/moda-ml-draft.asp?lingua=en&pag=6>

NT100 - eBIZ TCFUpstream version
NT11 - transport causal
NT12 - data source
NT16 - VAT rate or code
NT18 - message function
NT2 - third party qualifier
NT20 - price qualifier
NT22 - product type of an operation
NT29 - format of a date
NT3 - data format
NT38 - colour test
NT4 - end use
NT5 - action code
NT6 - coding system owner/issuer
NT7 - unit of measure
T1 - terms of payment
T10 - ISO3166 - Country
T13 - CFM properties of fabric
T16 - dyestuff type
T19 - fibre type
T2 - Modes of payment
T21 - type of document
T264 - fabric printing technology
T3 - terms of delivery
T38 - transport conditions
T4 - fabric piece inner packing (wrapping) 1
T40 - type of transport means
T41 - type of Allowance or Charge
T44 - additional code type
T45 - fabric print parameter type
T5 - fabric piece inner packing (wrapping) 2
T52 - fabric piece status
T6 - fabric piece outer packing
T61 - duty or tax or fee type
T62 - duty or tax or fee category
T8 - Modes of Transport
T9 - ISO4217 - Currency

ACKNOWLEDGEMENT



This action is part of the eBIZ-4.0 project, which has received funding from the European Union's COSME Programme (2014 - 2020).

DISCLAIMER

The content of this document represents the views of the authors only and is their sole responsibility; it cannot be considered to reflect the views of the European Commission and/or the Executive Agency for Small and Medium-sized Enterprises (EASME) or any other body of the European Union.

The European Commission and the Agency do not accept any responsibility for use that may be made of the information it contains.

Annex A

Representative images of the principal complex elements' structure.

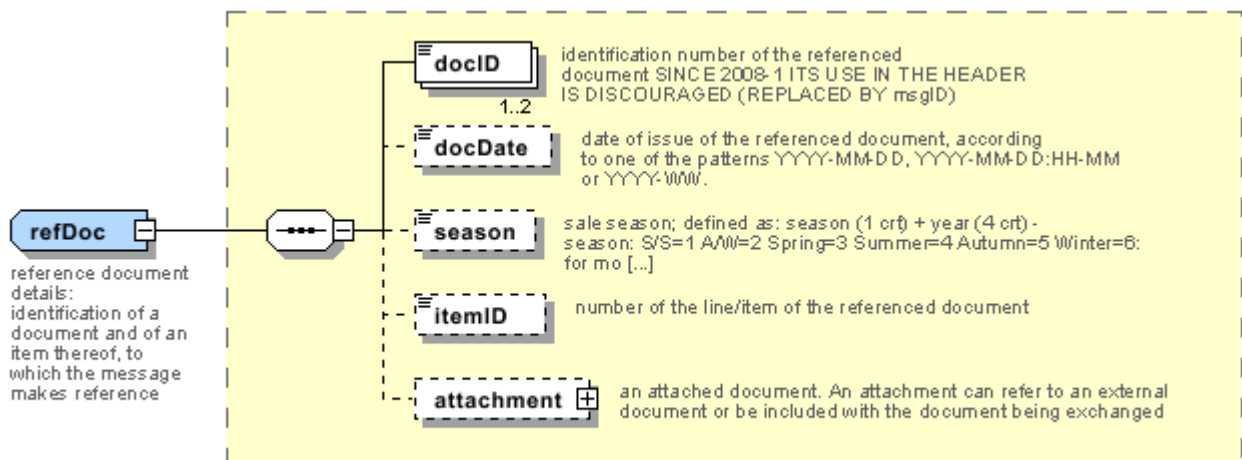
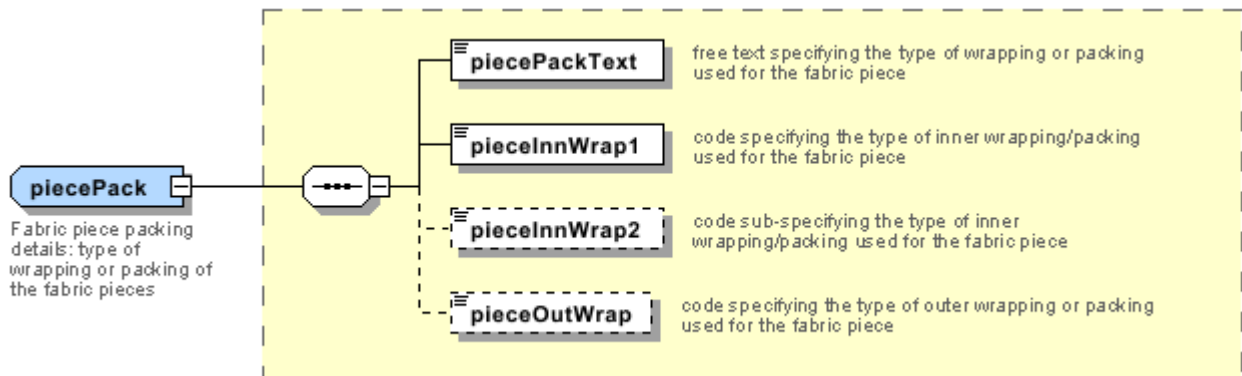
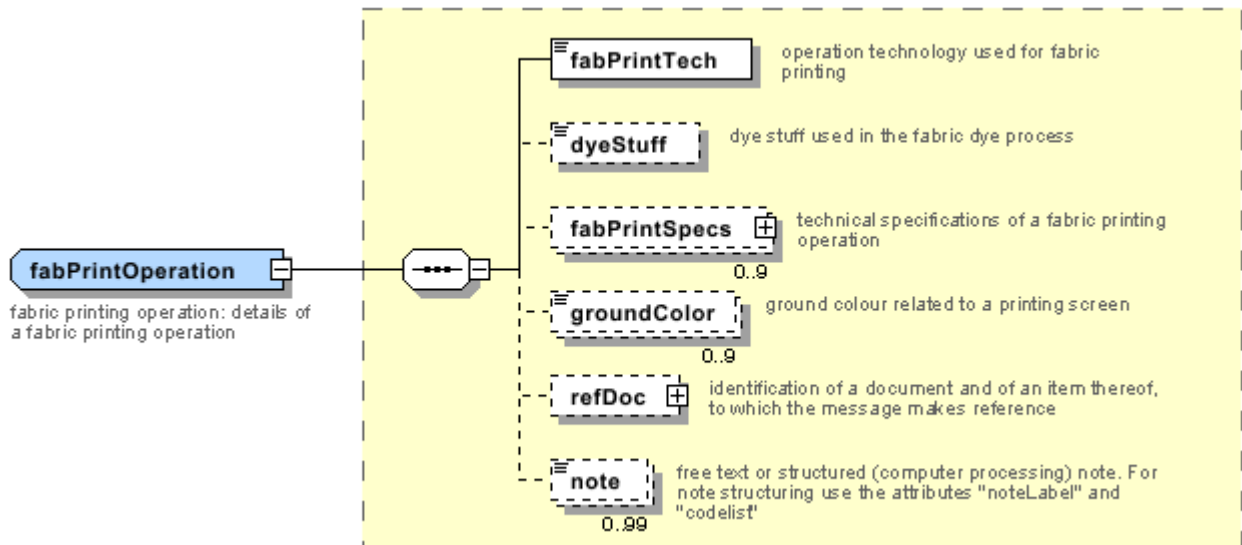

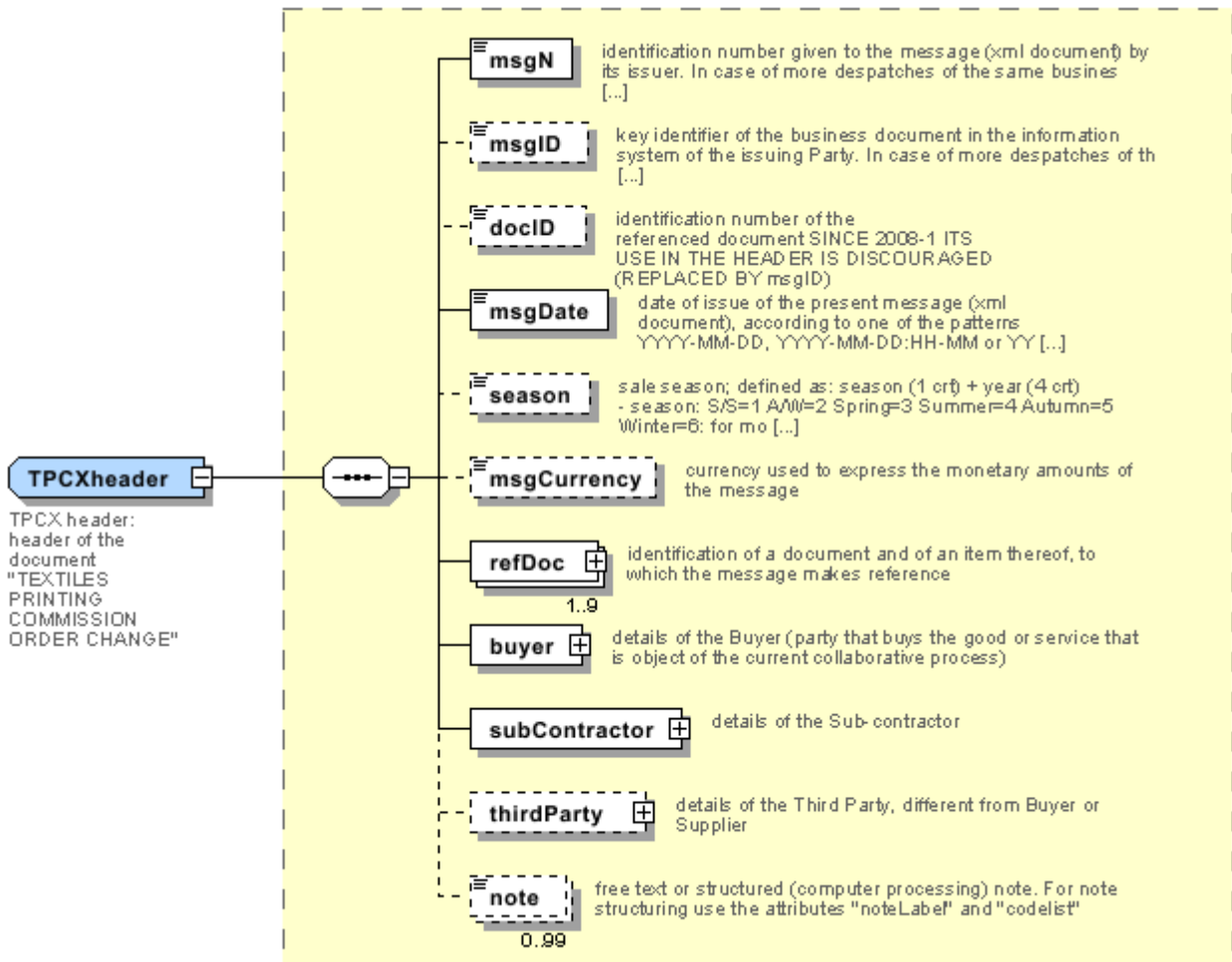
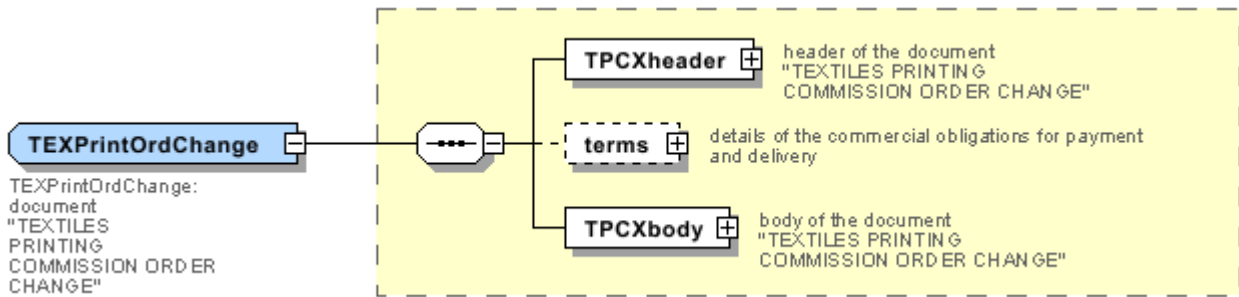

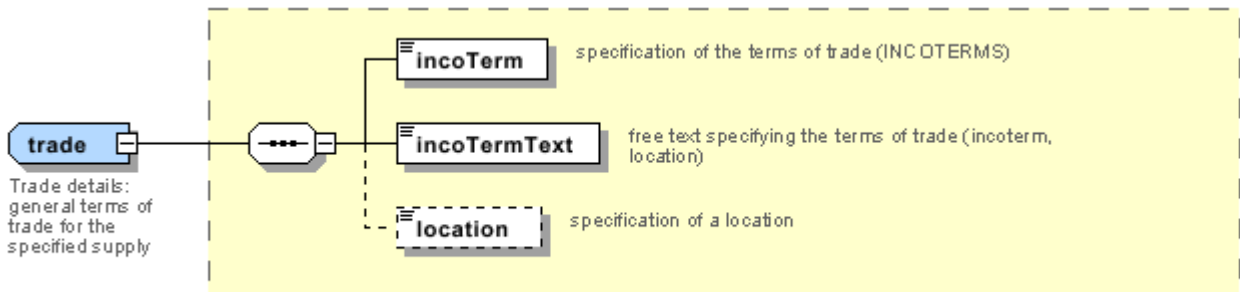
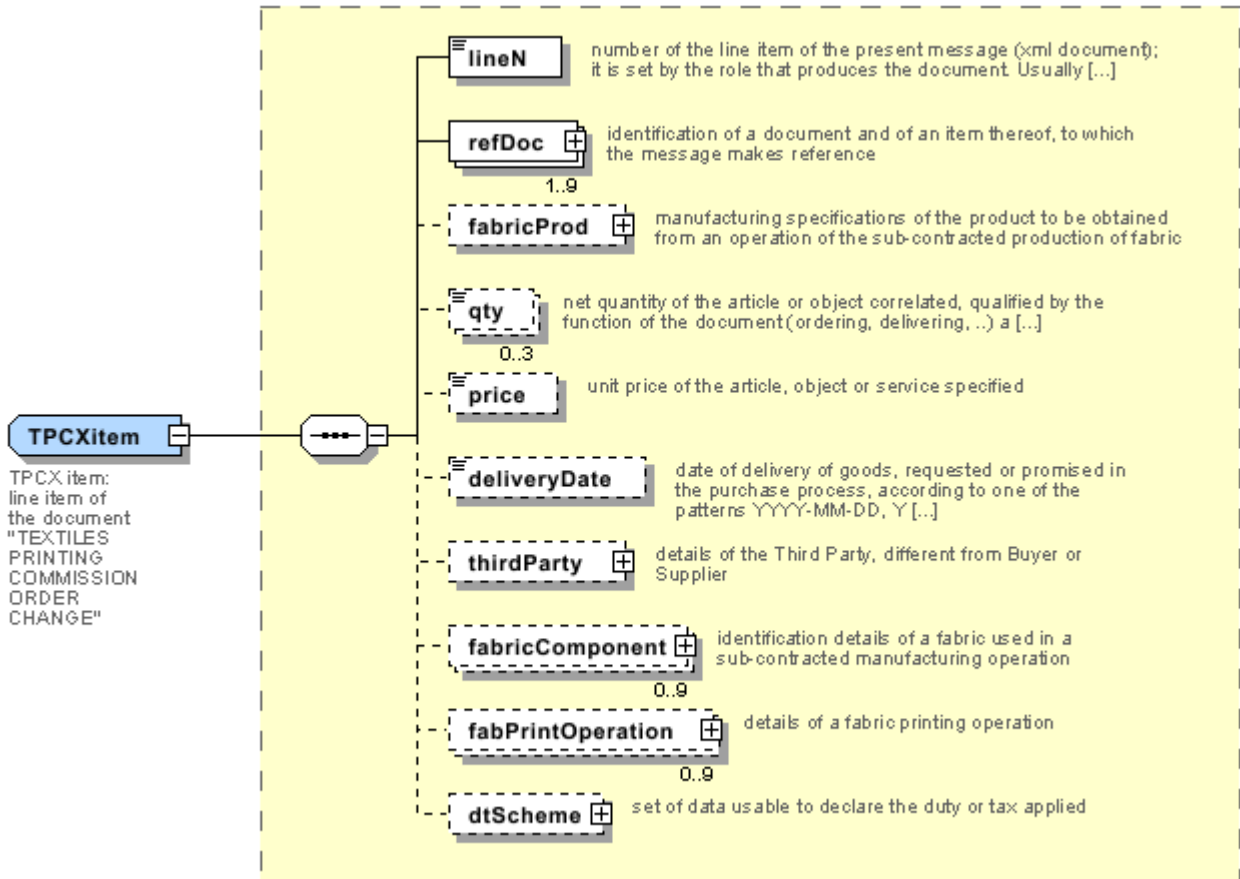

Annex B

NT100 - eBIZ TCFUpstream version

dictionary version

Agency name: eBIZ

tabella cod.: NT100

File codes list (Generic code): http://www.ebiz.enea.it/moda-ml/repository/codelist/draft/gc_NT100.xml

Code	Description	Adoption note	Date of insertion
2013-1	v2013-1		01/07/2013
2018-1	v2018-1		04/11/2018
draft	draft		08/09/2017

NT11 - transport causal

reason for the transport

Agency name: eBIZ

tabella cod.: NT11

File codes list (Generic code): http://www.ebiz.enea.it/moda-ml/repository/codelist/draft/gc_NT11.xml

Code	Description	Adoption note	Date of insertion
FOC	free of charge		
FRW	return from re-works		
FST	return from storage		
FWW	return from view		
FWK	return from works		
IST	in storage		
NWK	return non-worked		
RJC	return from rejection		
SEL	to sell		
STO	to storage		
VEW	to view		
WRK	to works		

NT12 - data source

party who has provided the data

Agency name: eBIZ

tabella cod.: NT12

File codes list (Generic code): http://www.ebiz.enea.it/moda-ml/repository/codelist/draft/gc_NT12.xml

Code	Description	Adoption note	Date of insertion
AC	internal test		
CO	external test		
CV	test after steaming		

NT16 - VAT rate or code

VAT rate or code (DEPRECATED, use dtScheme element)

tabella cod.: NT16

File codes list (Generic code): http://www.ebiz.enea.it/moda-ml/repository/codelist/draft/gc_NT16.xml

NT18 - message function

function performed by the present message with regards to the transmission

Agency name: eBIZ

tabella cod.: NT18

File codes list (Generic code): http://www.ebiz.enea.it/moda-ml/repository/codelist/draft/gc_NT18.xml

Code	Description	Adoption note	Date of insertion
CA	delete this document		01/07/2013
CP	copy		
OR	original		
RC	re-transmission for data correction		
RT	re-transmission		

NT2 - third party qualifier

Third Party role qualifier

Agency name: eBIZ

tabella cod.: NT2

File codes list (Generic code): http://www.ebiz.enea.it/moda-ml/repository/codelist/draft/gc_NT2.xml

Code	Description	Adoption note	Date of insertion
AG	Sales Agent		
CO	Quality Controller		
DC	Response to		
DF	Invoicee		
DI	Copy to (CC)		28/10/2014
DM	Consignee		
DP	Consignment address (Delivery Party)		
IM	Importer		
OR	Originator		10/09/2014
SP	Forwarder		
TX	Tax Representative		

NT20 - price qualifier

type of price with reference to discount and taxes

Agency name: eBIZ

tabella cod.: NT20

File codes list (Generic code): http://www.ebiz.enea.it/moda-ml/repository/codelist/draft/gc_NT20.xml

Code	Description	Adoption note	Date of insertion
GET	gross excluding taxes		
GIT	gross including taxes		
NET	net excluding taxes		
NIT	net including taxes		

NT22 - product type of an operation

level of the product (end or intermediate) yielded by an operation in a work cycle

Agency name: eBIZ

tabella cod.: NT22

File codes list (Generic code): http://www.ebiz.enea.it/moda-ml/repository/codelist/draft/gc_NT22.xml

Code	Description	Adoption note	Date of insertion
END	end-product		
INT	intermediate		

NT29 - format of a date

format used for the date

Agency name: eBIZ

tabella cod.: NT29

File codes list (Generic code): http://www.ebiz.enea.it/moda-ml/repository/codelist/draft/gc_NT29.xml

Code	Description	Adoption note	Date of insertion
D	YYYY-MM-DD		
M	YYYY-MM-DD:HH-MM		
W	YYYY-WW		

NT3 - data format

format of a string according to a customized User rule (local rule)

Agency name: eBIZ

tabella cod.: NT3

File codes list (Generic code): http://www.ebiz.enea.it/moda-ml/repository/codelist/draft/gc_NT3.xml

Code	Description	Adoption note	Date of insertion
EN4	GS1-GLN		01/07/2013
MD	mutually agreed		

NT38 - colour test

specification of colour test before the operation

tabella cod.: NT38

File codes list (Generic code): http://www.ebiz.enea.it/moda-ml/repository/codelist/draft/gc_NT38.xml

Code	Description	Adoption note	Date of insertion
1	only colour test		
2	with colour test		

NT4 - end use

specifies the final use of the product

Agency name: eBIZ

tabella cod.: NT4

File codes list (Generic code): http://www.ebiz.enea.it/moda-ml/repository/codelist/draft/gc_NT4.xml

Code	Description	Adoption note	Date of insertion
PC	test piece		
PR	production		
SA	Sample		10/09/2014
SC	samples card		
TI	patch		
TP	(test cut)		

NT5 - action code

action performed by the present line upon the referenced document line

Agency name: eBIZ

tabella cod.: NT5

File codes list (Generic code): http://www.ebiz.enea.it/moda-ml/repository/codelist/draft/gc_NT5.xml

Code	Description	Adoption note	Date of insertion
A	CANCELLED		
C	CONFIRMED		
N	NEW ORDER LINE (created by an order change)		
R	PROVISIONAL CONFIRMATION		
S	DEFINITIVE CONFIRMATION		
SA	suspension accepted		
SN	suspension not accepted		
SR	suspension request		
V	AMENDED		

NT6 - coding system owner/issuer

code specifying the organisation who has created or owns the coding or numbering system

Agency name: eBIZ

tabella cod.: NT6

File codes list (Generic code): http://www.ebiz.enea.it/moda-ml/repository/codelist/draft/gc_NT6.xml

Code	Description	Adoption note	Date of insertion
CL	Customer/buyer		
CO	Quality Controller		
EN	GS1 (ex-EAN International)		
ES	e-Stockflow		
FO	Supplier		
GS	GS1		01/07/2013
MF	VAT identifier		
ML	Moda-ML		
SP	Service Provider		

NT7 - unit of measure

specification of the unit of measure, it is a sub set of table Unit of Measure Code - UN/ECE REC 20 delivered by United Nations Economic Commission for Europe (UN/ECE)

Agency name: eBIZ / UN/ECE

tabella cod.: NT7

File codes list (Generic code): http://www.ebiz.enea.it/moda-ml/repository/codelist/draft/gc_NT7.xml

Other link: <http://docs.oasis-open.org/ubl/os-UBL-2.1/cl/gc/default/UnitOfMeasureCode-2.1.gc#>

Code	Description	Adoption note	Date of insertion
CMK	square centimetre		20/12/2017
CMQ	cubic centimetre		20/12/2017
CMT	centimetre		
CNE	centiNewton		
CO2TON	ton of CO2		10/09/2014
COUPLES	couples		
DMQ	cubic decimetre		
E37	pixel		11/04/2018
GRM	gram		
HUR	hour		

INH	inch		
KGM	kilogram		
KMT	kilometer		
KWH	kilowatthours		10/09/2014
LBR	pound		
MIN	minute		
MMK	centimetre		20/12/2017
MMK	square millimetre		20/12/2017
MTK	square metre		20/12/2017
MTQ	cubic metre		
MTR	metre		
NMB	numero		
ONZ	ounce		
P1	percent		
PPM	parts per milion		
PZ	piece		
RPM	rounds per metre		
YRD	yard		

T1 - terms of payment

code specifying the terms or time by which the payment must be done

Agency name: eBIZ

tabella cod.: T1

File codes list (Generic code): http://www.ebiz.enea.it/moda-ml/repository/codelist/draft/gc_T1.xml

Code	Description	Adoption note	Date of insertion
ANTICIP	PAYMENT IN ADVANCE		
BLCOLLECT/120D	BILL OF LADING 120 DD		
BLCOLLECT/30D	BILL OF LADING 30 DD		
BLCOLLECT/60D	BILL OF LADING 60 DD		
BLCOLLECT/90D	BILL OF LADING 90 DD		
CASH	PAYMENT ON DELIVERY		
CASHINV	PAYMENT ON RECEIPT OF INVOICE		
CREDOC/0D	DOCUMENTARY CREDIT FOR PAYM. AT SIGHT		
CREDOC/120	DOCUMENTARY CREDIT FOR PAYM. AT 120 DD		

CREDOC/150	DOCUMENTARY CREDIT FOR PAYM. AT 150 DD		
CREDOC/180	DOCUMENTARY CREDIT FOR PAYM. AT 180 DD		
CREDOC/30D	DOCUMENTARY CREDIT FOR PAYM. AT 30 DD		
CREDOC/45D	DOCUMENTARY CREDIT FOR PAYM. AT 45 DD		
CREDOC/60	DOCUMENTARY CREDIT FOR PAYM. AT 60 DD		
CREDOC/90	DOCUMENTARY CREDIT FOR PAYM. AT 90 DD		
DEL/10	PAYMENT AT 10 DD AFTER DELIVERY		
DOCOLLECT/120D	DOCUMENTARY COLLECTION AT 120 DD		
DOCOLLECT/30D	DOCUMENTARY COLLECTION AT 30 DD		
DOCOLLECT/60D	DOCUMENTARY COLLECTION AT 60 DD		
DOCOLLECT/90D	DOCUMENTARY COLLECTION AT 90 DD		
INV/120D	PAYMENT AT 120 DD AFTER RECEIPT OF INVOICE		
INV/150D	PAYMENT AT 150 DD AFTER RECEIPT OF INVOICE		
INV/180D	PAYMENT AT 180 DD AFTER RECEIPT OF INVOICE		
INV/30D	PAYMENT AT 30 DD AFTER RECEIPT OF INVOICE		
INV/45D	PAYMENT AT 45 DD AFTER RECEIPT OF INVOICE		
INV/60D	PAYMENT AT 60 DD AFTER RECEIPT OF INVOICE		
INV/90D	PAYMENT AT 90 DD AFTER RECEIPT OF INVOICE		
INVULTIMO	PAYMENT AT END MONTH RECEIPT INVOICE		
INVULTIMO/10D	PAYMENT 10 DD AFTER END MONTH RECEIPT INVOICE		
INVULTIMO/120D	PAYMENT 120 DD AFTER END MONTH RECEIPT INVOICE		
INVULTIMO/150D	PAYMENT 150 DD AFTER END MONTH RECEIPT INVOICE		
INVULTIMO/180D	PAYMENT 180 DD AFTER END MONTH RECEIPT INVOICE		
INVULTIMO/240D	PAYMENT 240 DD AFTER END MONTH RECEIPT INVOICE		
INVULTIMO/30D	PAYMENT 30 DD AFTER END MONTH RECEIPT INVOICE		
INVULTIMO/45D	PAYMENT 45 DD AFTER END MONTH RECEIPT INVOICE		
INVULTIMO/60D	PAYMENT 60 DD AFTER END MONTH RECEIPT INVOICE		
INVULTIMO/90D	PAYMENT 90 DD AFTER END MONTH RECEIPT INVOICE		
NOPAY	WITHOUT PAYMENT		
RECREDOC/0D	IRREVOC. DOCUMENTARY CREDIT FOR PAYM. AT SIGHT		
RECREDOC/120D	IRREVOC. DOCUMENTARY CREDIT FOR PAYM. AT 120 DD		
RECREDOC/150D	IRREVOC. DOCUMENTARY CREDIT FOR PAYM. AT 150 DD		
RECREDOC/180D	IRREVOC. DOCUMENTARY CREDIT FOR PAYM. AT 180 DD		
RECREDOC/30D	IRREVOC. DOCUMENTARY CREDIT FOR PAYM. AT 30 DD		
RECREDOC/45D	IRREVOC. DOCUMENTARY CREDIT FOR PAYM. AT 45 DD		

RECREDOC/60D	IRREVOC. DOCUMENTARY CREDIT FOR PAYM. AT 60 DD		
RECREDOC/90D	IRREVOC. DOCUMENTARY CREDIT FOR PAYM. AT 90 DD		
ULTIMO	PAYMENT BY END MONTH OF DELIVERY		
ULTIMO/10	PAYMENT AT 10 DD AFTER END MONTH OF DELIVERY		

T10 - ISO3166 - Country

code of the nation

Agency name: ISO

tabella cod.: T10

File codes list (Generic code): http://www.ebiz.enea.it/moda-ml/repository/codelist/draft/gc_T10.xml

Table not printed: there are 239 elements, more than the maximum specified for printing: 99.

T13 - CFM properties of fabric

code of the physical or mechanical parameter used to define a "technical characteristic of the fabric" (see Fabric technical sheet)

tabella cod.: T13

File codes list (Generic code): http://www.ebiz.enea.it/moda-ml/repository/codelist/draft/gc_T13.xml

Code	Description	Adoption note	Date of insertion
CMA	resistance to pilling (UNI.E.1512434)		
CMB	seam slippage - warp (NFG7117)		
CMC	seam slippage - weft (NFG7117)		
CMD	breaking strength - warp (ISO 1394-1)		
CME	breaking strength - weft (ISO 1394-1)		
CMF	resistance to abrasion (EN 12947)		
CMH	tear strength (ISO 9290)		
CMI	crease recovery (ISO 9867)		
CMJ	elongation - warp (BS 4294/68)		
CMK	elongation - weft (BS 4294/68)		
CML	tear resistance - warp		
CMM	tear resistance - weft		
CMN	resistance to bending		
CMP	spray test		
SLA	colour fastness to light (ISO 105-B02)		

SLB	colour fastness to washing (ISO 105-C06)		
SLC	colour fastness to dry cleaning (ISO 105-D01)		
SLD	colour fastness to spotting water (ISO 105-E07)		
SLG	colour fastness to alkaline perspiration (ISO 105-E04)		
SLH	colour fastness to acid perspiration (ISO 105-E04)		
SLI	colour fastness to dry rubbing (ISO 105-X12)		
SLJ	colour fastness to wet rubbing (ISO 105-X12)		
SLK	colour fastness to dry ironing (ISO 105-X11)		
SLM	colour fastness to wet ironing (ISO 105-X11)		
SLW	colour fastness to water (ISO 105-E01)		
SLX	colour fastness to Xeno-light		
SLZ	colour fastness to rubbing org. Solv. (ISO 105-D02)		
STA	dimensional stability to steaming press - length (DIN 53894-2)		
STB	dimensional stability to steaming press - width (DIN 53894-2)		
STC	dimensional stability to washing - length (ISO 5077+6330)		
STD	dimensional stability to washing - width (ISO 5077+6330)		
STE	dimensional stability to dry cleaning - length (ISO 3175)		
STF	dimensional stability to dry cleaning - width (ISO 3175)		

T16 - dyestuff type

dye stuff used in the fabric dye process

Agency name: eBIZ

tabella cod.: T16

File codes list (Generic code): http://www.ebiz.enea.it/moda-ml/repository/codelist/draft/gc_T16.xml

Code	Description	Adoption note	Date of insertion
AC	chrome acid dyestuff		
AN	acid dyestuff		
CA	basic dyestuff		
DI	direct dyestuff		
DS	disperse dyestuff		
NP	naphtol dyestuff		
PI	pigment		01/07/2013
PM	premetallized dyestuff		
RE	reactive dyestuff		

SU	sulfur		01/07/2013
----	--------	--	------------

T19 - fibre type

type of fibre used in a textile product

Agency name: eBIZ

tabella cod.: T19

File codes list (Generic code): http://www.ebiz.enea.it/moda-ml/repository/codelist/draft/gc_T19.xml

Code	Description	Adoption note	Date of insertion
AB	abaca		20/08/2018
AC	acetate		
AF	other fibres		
AG	alginic fibre		
AL	alfa		20/08/2018
CA	hemp		
CC	coir (coconut)		20/08/2018
CL	chlorofibre		
CO	cotton		
CU	cuprous		
EA	elastan		
EL	Elastodiene		20/08/2018
FL	fluorofibre		
GI	broom		20/08/2018
GL	textile glass		
HA	hair		20/08/2018
HE	henequen		20/08/2018
HL	mixed linen		
HL	cotton linen union		20/08/2018
JU	jute		
KE	kenaf		20/08/2018
KP	kapoc		20/08/2018
LI	linen		
LY	lyocell		20/08/2018
MA	modacrylic		
MD	modal		

ME	metallized		
MG	maguey		20/08/2018
PA	polyamide		
PB	polyureic		
PC	acrylic		
PE	polyethylene		
PI	paper		20/08/2018
PL	polyester		
PM	polyimide		
PP	polypropylene		
PR	proteic		
PU	polyurethane		
RA	mamie		20/08/2018
SE	silk		
SI	sisal		20/08/2018
SN	sun		20/08/2018
TA	triacetate		
TR	textile residues or unspecified composition		20/08/2018
TV	trivinyll		
VI	viscose		
VY	vinylal		
WA	angora		
WB	beaver		20/08/2018
WC	cashgora		
WG	vicuna		
WK	camel		
WL	llama		
WM	mohair		
WN	lapin		20/08/2018
WO	wool		
WP	alpaca		
WS	cashmere		
WT	Oteer		20/08/2018
WU	guanaco		
WV	virgin wool		

WY	yack		
----	------	--	--

T2 - Modes of payment

way or means of payment

Agency name: eBIZ

tabella cod.: T2

File codes list (Generic code): http://www.ebiz.enea.it/moda-ml/repository/codelist/draft/gc_T2.xml

Code	Description	Adoption note	Date of insertion
BB	bank transfer		
IA	collection through Agent		
IS	collection through Forwarder		
RB	bank receipt		
RD	remittance		
SW	bank SWIFT		
TR	bank draft		

T21 - type of document

type or class to which the referenced document belongs

Agency name: eBIZ

tabella cod.: T21

File codes list (Generic code): http://www.ebiz.enea.it/moda-ml/repository/codelist/draft/gc_T21.xml

Code	Description	Adoption note	Date of insertion
BOR	blanket order		01/02/2018
CAT	Price catalogue - tech sheet		
CEO	Certificate of origin		13/04/2018
CER	Certificate		13/04/2018
COC	colour card		
CRN	Credit note		08/09/2017
CTO	Checking order		01/07/2013
CTR	Contract		
CXF	CxF3 file		01/07/2013
DAD	Darn order		

DDT	ddt		
DEA	Despatch advise		
DER	Despatch request		
DR	Document Request		02/12/2014
FOR	Forecast		02/12/2014
GSO	Garment stock offer		
GSX	Garment stock offer change		
INV	Invoice		
KCC	Knitting-Clothing Commission Order		02/12/2014
KCI	Garment in Work Inventory Report		02/12/2014
M2M	Made to Measure Production Order		02/12/2014
MAS	Master marker		
MCI	Visual merchandising instruction		13/04/2018
OCH	Order change		
OFF	Offer		
ORD	Purchase order		
ORP	Order response		
OSR	order status request		
OSS	Offer status		02/12/2014
OST	Order status		
OUR	our reference		
QR	Quality Report		02/12/2014
RAI	Raw Material in Work Inventory Report		02/12/2014
RDC	Raw dyeing commission order		
RDH	Raw dyeing order change		
RDR	Raw dyeing order response		
REA	Receiving advise		
REQ	Request for Offer		
RET	Return		02/12/2014
RSC	Spinning commission order		
RSH	Spinning order change		
RSR	Spinning order response		
SCL	process sheet		
TFC	Textile dyeing-finishing commission order		
TFX	Textile Dyeing-Finishing Order Change		02/12/2014

TPC	Textile printing commission order		
TPX	Textile Printing Order Change		02/12/2014
TWI	Textile in work inventory		
VMI	visual merchandising instructions		01/02/2018
WAC	Warping commission order		
WEC	Weaving commission order		
YDC	Yarn dyeing commission order		
YDH	Yarn dyeing order change		
YDR	Yarn dyeing order response		
YTC	Twisting commission order		
YWI	Yarn in work inventory		

T264 - fabric printing technology

operation technology used for fabric printing

Agency name: eBIZ

tabella cod.: T264

File codes list (Generic code): http://www.ebiz.enea.it/moda-ml/repository/codelist/draft/gc_T264.xml

Code	Description	Adoption note	Date of insertion
BL	block printing		
DE	devoré printing		
DI	discharge printing		
FC	flock printing		
FL	flat printing		
HA	hand printing		
IJ	inkjet printing		01/07/2013
RE	resist printing		
RO	roller printing		
RS	rotary screen printing		
SC	screen printing		
TR	transfer printing		

T3 - terms of delivery

specification of the terms of trade (INCOTERMS)

Agency name: Incoterms

tabella cod.: T3

File codes list (Generic code): http://www.ebiz.enea.it/moda-ml/repository/codelist/draft/gc_T3.xml

Code	Description	Adoption note	Date of insertion
CFR	COST AND FREIGHT (named port of destination)		
CIF	COST, INSURANCE AND FREIGHT (named port of destination)		
CIP	CARRIAGE AND INSURANCE PAID (named place of destination)		
CP T	CARRIAGE PAID (named place of destination)		
DAF	DELIVERED AT FRONTIER (named place)	according to Incoterms® 2010 it is obsolete	08/12/2017
DAP	Delivered at Place of destination (named place of destination)	according to Incoterms® 2010	08/12/2017
DAT	Delivered at Terminal (named place of destination)	according to Incoterms® 2010	08/12/2017
DDP	DELIVERED DUTY PAID (named place of destination)		
DDU	DELIVERED DUTY UNPAID (named place of destination)	according to Incoterms® 2010 it is obsolete, use DAP	08/12/2017
DEQ	DELIVERED EX-QUAY (named port of destination)	according to Incoterms® 2010 it is obsolete	08/12/2017
DES	DELIVERED EX-SHIP (named port of destination)	according to Incoterms® 2010 it is obsolete	08/12/2017
EXW	EX WORKS (named place)		
FAS	FREE ALONGSIDE SHIP (named port of shipment)		
FCA	FREE CARRIER (named place)		
FOB	FREE ON BOARD (named port of shipment)		

T38 - transport conditions

special condition of transport or special service requested to the Forwarder

tabella cod.: T38

File codes list (Generic code): http://www.ebiz.enea.it/moda-ml/repository/codelist/draft/gc_T38.xml

Code	Description	Adoption note	Date of insertion
ACC	arrange customs clearance		
CAL	Carrier loads		
CAU	Carrier unloads		
CMR	CMR carnet		
FFN	freight forwarders national conditions		
FLD	special agreement for full loading		
NCC	do not arrange customs clearance		
PPB	packaging paid by Buyer		
PPS	packaging paid by Supplier		
PRO	proof of delivery		
RFR	return container free		
RPC	return container paid by Customer		
RPS	return container paid by Supplier		
SHL	Shipper loads		
SHU	Consignee unloads		

T4 - fabric piece inner packing (wrapping) 1

code specifying the type of inner wrapping/packing used for the fabric piece

Agency name: eBIZ

tabella cod.: T4

File codes list (Generic code): http://www.ebiz.enea.it/moda-ml/repository/codelist/draft/gc_T4.xml

Code	Description	Adoption note	Date of insertion
A	Folded, whole width		
B	Folded, doubled		
C	Folded, tube products		
D	Spoiled, whole width		
E	Spoiled, doubled, pli: left		
F	Spoiled, doubled, pli: right		
G	Rolled, whole width, single item		
H	Rolled, whole width, several items		
I	Rolled, doubled		
J	Rolled, tube products		

T40 - type of transport means

means of transport, in general or referred to a specific leg

Agency name: eBIZ

tabella cod.: T40

File codes list (Generic code): http://www.ebiz.enea.it/moda-ml/repository/codelist/draft/gc_T40.xml

Code	Description	Adoption note	Date of insertion
AIR	aircraft		
SHP	ship		
TRU	truck		
VAN	van		

T41 - type of Allowance or Charge

coded specification of an Allowance or Charge (elaborated from UNECE 4465)

Agency name: eBIZ

tabella cod.: T41

File codes list (Generic code): http://www.ebiz.enea.it/moda-ml/repository/codelist/draft/gc_T41.xml

Code	Description	Adoption note	Date of insertion
1	Agreed settlement		19/08/2018
10	Costs for draft		19/08/2018
11	Bank charges	DEPRECATED, use C BK	19/08/2018
12	Agent commission		19/08/2018
14	Wrong delivery		19/08/2018
15	Goods returned to agent		19/08/2018
16	Goods partly returned		19/08/2018
17	Transport damage		19/08/2018

19	Trade discount		19/08/2018
2	Below specification goods		19/08/2018
20	Deduction for late delivery	DEPRECATED, use C WB	19/08/2018
21	Advertising costs		19/08/2018
22	Customs duties		19/08/2018
23	Telephone and postal costs		19/08/2018
24	Repair costs		19/08/2018
25	Attorney fees		19/08/2018
26	Taxes		19/08/2018
3	Damaged goods		19/08/2018
30	Direct payment to seller		19/08/2018
32	Goods not delivered		19/08/2018
33	Late delivery		19/08/2018
35	Goods returned		19/08/2018
36	Invoice not received		19/08/2018
37	Credit note to debtor/not to us		19/08/2018
38	Deducted bonus		19/08/2018
39	Deducted discount		19/08/2018
4	Short delivery		19/08/2018
40	Deducted freight costs		19/08/2018
41	Deduction against other invoices		19/08/2018
42	Credit balance(s)		19/08/2018

45	Debit note to seller		19/08/2018
46	Discount beyond terms		19/08/2018
48	Allowance/charge error		19/08/2018
49	Substitute product		19/08/2018
50	Terms of sale error		19/08/2018
52	Wrong invoice		19/08/2018
53	Duplicate invoice		19/08/2018
54	Weight error		19/08/2018
55	Additional charge not authorized		19/08/2018
56	Incorrect discount		19/08/2018
57	Price change		19/08/2018
58	Variation		19/08/2018
59	Chargeback		19/08/2018
65	Settlement to agent		19/08/2018
66	Cash discount		19/08/2018
7	Payment on account		19/08/2018
70	Wrong monetary amount resulting from incorrect free goods quantity		19/08/2018
72	Temporary special promotion		19/08/2018
73	Difference in tax rate		19/08/2018
74	Quantity discount		19/08/2018
75	Promotion discount		19/08/2018
76	Cancellation deadline passed		19/08/2018

77	Pricing discount		19/08/2018
78	Volume discount		19/08/2018
79	Sundry discount		19/08/2018
8	Returnable container charge included		19/08/2018
9	Invoice error		19/08/2018
AW A	bonus for works ahead of schedule		
CBK	bank charges		
CCR	servizio di corriere		
CIN	insurance		
CLB	labelling		
CPK	packing		
CSP	special packing		
CW B	penalty for works behind schedule		

T44 - additional code type

qualifier of the additional coding of a product

Agency name: eBIZ

tabella cod.: T44

File codes list (Generic code): http://www.ebiz.enea.it/moda-ml/repository/codelist/draft/gc_T44.xml

Code	Description	Adoption note	Date of insertion
CC	colour card		
CL	sales collection		
CO	company identification code		08/09/2017
DY	dye number		
LT	lot number		
MDI	Made in		08/09/2017
MS	manufacturing state		
PKG	packaging		09/09/2014
PL	product line		

RGB	RGB value		
SE	selvedge code		

T45 - fabric print parameter type

code specifying a characteristic or parameter of the fabric printing

Agency name: eBIZ

tabella cod.: T45

File codes list (Generic code): http://www.ebiz.enea.it/moda-ml/repository/codelist/draft/gc_T45.xml

Code	Description	Adoption note	Date of insertion
NC	number of colours		
RL	repeat length		
RW	repeat width		

T5 - fabric piece inner packing (wrapping) 2

code specifying the sub-type of inner wrapping/packing used for the fabric piece

Agency name: eBIZ

tabella cod.: T5

File codes list (Generic code): http://www.ebiz.enea.it/moda-ml/repository/codelist/draft/gc_T5.xml

Code	Description	Adoption note	Date of insertion
A	Open		
B	Folded once, not looped		
C	Folded twice, not looped		
H	Folded once, looped		
I	Folded twice, looped		
J	Without inner object, right side inside		
K	On carton or spooling plank, right side inside		
L	On spool (for pressure sensitive products), right side inside		
M	Without inner object, left side inside		
N	On carton or spooling plank, left side inside		
O	On spool (for pressure sensitive products), left side inside		
P	Without inner object, right side inside (deprecated code)		
Q	On carton, right side inside		

R	On wooden stick, right side inside		
S	Without inner object, left side inside (deprecated code)		
T	On carton, left side inside		
U	On wooden stick, left side inside		

T52 - fabric piece status

code used to describe the status of a fabric piece with reference to the control

Agency name: eBIZ

tabella cod.: T52

File codes list (Generic code): http://www.ebiz.enea.it/moda-ml/repository/codelist/draft/gc_T52.xml

Code	Description	Adoption note	Date of insertion
0	first registration		
C	registration from return		
F	stopped		
H	handling		
R	returned		
S	held		
T	deliverable		

T6 - fabric piece outer packing

code specifying the type of outer wrapping or packing used for the fabric piece

Agency name: eBIZ

tabella cod.: T6

File codes list (Generic code): http://www.ebiz.enea.it/moda-ml/repository/codelist/draft/gc_T6.xml

Code	Description	Adoption note	Date of insertion
0	Not wrapped		
1	Totally wrapped		
2	Wrapped, one side open		
3	Wrapped, both sides open		
4	Wrapped, one side open, with show corner		
5	Wrapped in cartons		
6	Double wrapped		

T61 - duty or tax or fee type

duty or tax or fee type

Agency name: eBIZ

tabella cod.: T61

File codes list (Generic code): http://www.ebiz.enea.it/moda-ml/repository/codelist/draft/gc_T61.xml

Code	Description	Adoption note	Date of insertion
BOL	stamp duty		01/07/2013
CUD	customs duty		01/07/2013
ENV	environmental tax		01/07/2013
FRE	no tax		01/07/2013
OTH	other tax charges		01/07/2013
VAT	value added tax		01/07/2013

T62 - duty or tax or fee category

duty or tax or fee category

Agency name: eBIZ

tabella cod.: T62

File codes list (Generic code): http://www.ebiz.enea.it/moda-ml/repository/codelist/draft/gc_T62.xml

Code	Description	Adoption note	Date of insertion
AA	lower than standard rate		01/07/2013
E	tax not applicable		01/07/2013
H	higher than standard rate		01/07/2013
O	outside scope of tax		01/07/2013
S	standard rate		01/07/2013
Z	zero rate goods		01/07/2013

T8 - Modes of Transport

way of transport, in general or referred to the specified leg

Agency name: eBIZ

tabella cod.: T8

File codes list (Generic code): http://www.ebiz.enea.it/moda-ml/repository/codelist/draft/gc_T8.xml

Code	Description	Adoption note	Date of insertion
1	MARITIME TRANSPORT		
10	Courier		01/07/2013
2	RAIL TRANSPORT		
3	ROAD TRANSPORT		
4	AIR TRANSPORT		
5	MAIL		
6	AIR + SHIP TRANSPORT		
8	INLAND WATER TRANSPORT		
9	MODE UNKNOWN		

T9 - ISO4217 - Currency

currency code

Agency name: ISO

tabella cod.: T9

File codes list (Generic code): http://www.ebiz.enea.it/moda-ml/repository/codelist/draft/gc_T9.xml

Table not printed: there are 205 elements, more than the maximum specified for printing: 99.