



<http://www.ebiz-tcf.eu>

## IMPLEMENTATION GUIDE

includes COMPARISON BETWEEN CURRENT and LAST  
PREVIOUSLY RELEASED VERSION

TRANSACTION "RAW MATERIAL DYEING REQUEST"

Version: v2018-1

Date of release: 18/7/2019

Document code: G047rv

technical Documentation: <http://www.ebiz.enea.it>

XML Schemas repository: <http://www.ebiz.enea.it/moda-ml/repository/schema/v2018-1/default.asp>

Guides repository: <http://www.ebiz.enea.it/moda-ml/repository/guide/v2018-1/default.asp>

Guide filename: G047rv-eBIZ-RawMaterialDyeingRequest.pdf

# 1. BUSINESS DESCRIPTION

## 1.1 Scope

The present guide has been issued to assist the companies of the Textile-Clothing sector in the implementation of the standard XML document type "RAW MATERIAL DYEING REQUEST", providing all the instruction required for its use in the context of e-commerce between Subcontractors and their Customers shown in the enclosed diagram

All the rules required for the construction and validation of the document are embedded into the specific XML-Schema, which is detailed in section "Implementation guide".

## 1.2 Generalities

The Request is used by a Yarn Producer to request from a Subcontractor an Offer for the dyeing of a raw material.

The Request is structured in four levels:

Macro-type of Work Requested = document root (7 types of Request)

Product Family = document qualifier (type of product with reference to the manufacturing process; e.g.: combed yarn, jacquard weaved fabric, ..)

Product Specifications = "xxxSpecs" (technical characteristics and properties of the product)

Operations requested 0 "XXXMnfrOperation" (details of the works requested)

Quantities, unit measures and prices must be referred to the third level (Line Item)

## 1.3. Possible scenario

Subcontracted dyeing of raw material

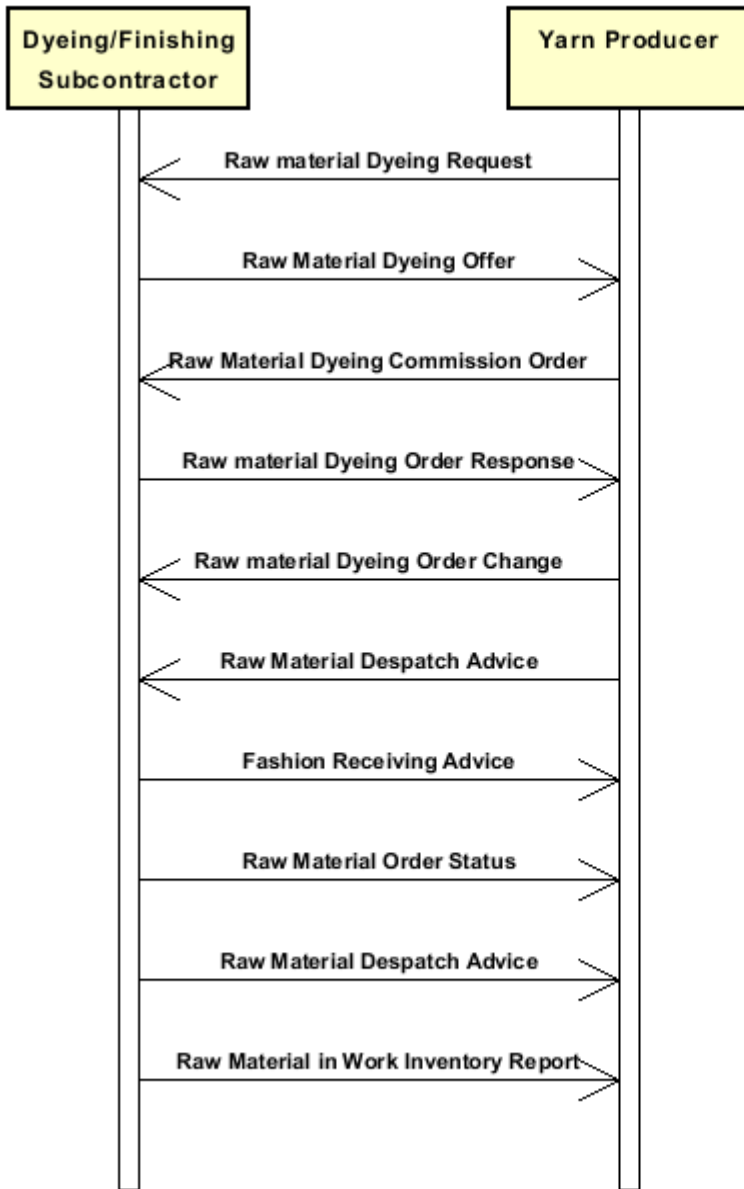

## 2. IMPLEMENTATION GUIDE

### 2.1 General structure of XML document

All the business data that can be exchanged through this class of documents are shown in the following "document structure", that provides a simplified vision of the Schema.

In particular:

- the two numbers following each element define its "cardinality" (minimum and maximum number of occurrences); the minimum equal zero indicates that the element is optional, the minimum greater than zero indicates that is mandatory;
- the bold character denotes the complex elements (aggregates of simple elements) that were built for the sake of functionality and re-usability of some complex informations sets. The child elements in each parent element are easily spotted as "indented";
- the symbol "@" denotes an attribute of the preceding element; here "the usage indicator (optional, required, ...)" is shown in square brackets.

#### Legenda

- N: new element
- U: updated properties
- P: changes in children
- p: is a changed child
- A: changes in attributes
- a: is a new or changed attribute
- \*: is a subtype

### Structure

#### RAWDyeRequest

@msgfunction [Optional] [Default= OR]

@rawProcQualifier [Required]

@version [Optional] [Default= 2018-1]

@useProfile [Optional]

```
| RQheader 1-1 (P)
| | msgN 1-1
| | - choose -
| | msgID 0-1
| | - or -
| | docID 0-1
| | @numberingOrg [Optional]
| | - end choose -
| | msgDate 1-1
| | @dateForm [Optional]
| | season 0-1 (A)
| | @numberingOrg [Optional] (a)
| | @codeList [Optional] (a)
| | @listName [Optional] (a)
| | @listVersion [Optional] (a)
| | validityStart 0-1
| | @dateForm [Optional]
| | validityEnd 1-1
| | @dateForm [Optional]
| | refDoc 0-9 (P)
| | @docType [Required]
| | | docID 1-2 (p)
| | | @numberingOrg [Optional]
| | | docDate 0-1
| | | @dateForm [Optional]
```

- season 0-1 (A)
- @numberingOrg [Optional] (a)
- @codeList [Optional] (a)
- @listName [Optional] (a)
- @listVersion [Optional] (a)
- itemID 0-1 (U)
- attachment 0-1 (N)**
- @uid [Optional]
- | fileName 0-1 (N)
- | @numberingOrg [Optional] (a)
- | binaryObject 0-1 (N)
- | @format [Optional] (N)
- | @mime [Optional] (N)
- | @encoding [Optional] (N)
- | @characterSet [Optional] (N)
- externalReference 0-99 (N)**
- | uri 1-1 (N)
- | @isURL [Optional] [Default= true] (Na)
- | mimeTypeCode 0-1 (N)
- | formatCode 0-1 (N)
- | encodingCode 0-1 (N)
- | characterSetCode 0-1 (N)

**buyer 1-1 (AP)**

- @logo [Optional]
- @sender [Optional] (a\*)
- | id 1-1 (p)
- | @numberingOrg [Optional]
- | additionalIdentifier 0-9 (N)
- | @numberingOrg [Optional] (a)
- | @idQualifier [Optional] (Na)
- | legalName 0-1 (U)
- | dept 0-1
- | subDept 0-1 (N)
- | person 0-1
- | @email [Optional]
- | @phone [Optional]
- | @fax [Optional]
- | street 0-1
- | city 0-1
- | subCountry 0-1
- | country 0-1
- | postCode 0-1

- choose -

**supplier 0-1 (AP)**

- @logo [Optional]
- @sender [Optional] (a\*)
- | id 1-1
- | @numberingOrg [Optional]
- | additionalIdentifier 0-9 (N)
- | @numberingOrg [Optional] (a)
- | @idQualifier [Optional] (Na)
- | legalName 0-1 (U)
- | dept 0-1
- | subDept 0-1 (N)
- | person 0-1
- | @email [Optional]
- | @phone [Optional]
- | @fax [Optional]
- | street 0-1
- | city 0-1
- | subCountry 0-1

```

| | | country 0-1
| | | postCode 0-1
- or -
| | subContractor 0-1 (AP)
| | @sender [Optional] (a*)
| | | id 1-1
| | | @numberingOrg [Optional]
| | | legalName 0-1 (U)
| | | dept 0-1
| | | subDept 0-1 (N)
| | | person 0-1
| | | @email [Optional]
| | | @phone [Optional]
| | | @fax [Optional]
| | | street 0-1
| | | city 0-1
| | | subCountry 0-1
| | | country 0-1
| | | postCode 0-1
- end choose -
| | thirdParty 0-5 (AP)
| | @VAT [Optional]
| | @role [Required]
| | @sender [Optional] (a*)
| | | id 1-1
| | | @numberingOrg [Optional]
| | | legalName 0-1 (U)
| | | dept 0-1
| | | subDept 0-1 (N)
| | | person 0-1
| | | @email [Optional]
| | | @phone [Optional]
| | | @fax [Optional]
| | | street 0-1
| | | city 0-1
| | | subCountry 0-1
| | | country 0-1
| | | postCode 0-1
| | note 0-99
| | @numberingOrg [Optional]
| | @codeList [Optional]
| | @noteLabel [Optional]
| | terms 0-1 (P)
| | | payment 0-5
| | | @finDiscount [Optional]
| | | @finSurcharge [Optional]
| | | - choose -
| | | | payTerm 1-1
| | | | - or -
| | | | payTermText 1-1 (U)
| | | | - end choose -
| | | | payMode 0-1
| | | insPayment 0-5
| | | @part [Required]
| | | - choose -
| | | | payTerm 1-1
| | | | - or -
| | | | payTermText 1-1 (U)
| | | | - end choose -
| | | | payMode 0-1

```

```

| | trade 0-1
| | - choose -
| | | incoTermText 1-1 (U)
| | - or -
| | | incoTerm 1-1
| | - end choose -
| | | location 0-1
| | | @LRI [Optional]
| | transInfo 0-5 (pAP)
| | @transReason [Optional]
| | @progr [Optional] (N)
| | | transMode 1-1
| | | carrier 0-1
| | | deliveryPlace 0-1 (U)
| | | grossWeight 0-1
| | | @um [Required]
| | | netWeight 0-1
| | | @um [Required]
| | | transMeans 0-1
| | | transCondition 0-3
| | | transConditionText 0-1 (U)
| | | despatchPlace 0-1 (N)
| | | despatchDate 0-1 (N)
| | | @dateForm [Optional] (a)
| | | delEffectiveDate 0-1 (p)
| | | @dateForm [Optional]
| | allowanceCharge 0-9 (A)
| | @um [Optional] (a)
| | @VAT [Optional]
| | @minQty [Optional] (a)
| | @currency [Optional] (a)
| | @maxQty [Optional] (N)
| | @isCharge [Optional] (N)
| | - choose -
| | | AC_category 1-1
| | - or -
| | | AC_categoryText 1-1 (U)
| | - end choose -
| | - choose -
| | | AC_percent 1-1
| | - or -
| | | AC_amount 1-1 (A)
| | | @currency [Optional] (a)
| | - end choose -
| | | dtScheme 0-1 (P)
| | | @taxType [Required]
| | | | taxCategory 0-1
| | | | taxRate 0-1
| | | | legalRef 0-1 (A)
| | | | @numberingOrg [Optional]
| | | | @codeList [Optional]
| | | | @listName [Optional]
| | | | @listVersion [Optional]
| | | | note 0-99
| | | | @numberingOrg [Optional]
| | | | @codeList [Optional]
| | | | @noteLabel [Optional]
| | RDRQbody 1-1
| | | RDRQitem 1-unbounded (P)
| | | | lineN 1-1

```

```

| | | @VAT [Optional]
| | | rawSpecs 0-9
| | | - choose -
| | | | rawCharText 1-1 (U)
| | | - or -
| | | | rawChar 1-1
| | | - end choose -
| | | | specValue 0-1
| | | | @um [Optional]
| | | | @source [Optional]
| | | | @method [Optional]
| | | | @application [Optional]
| | | | @CV [Optional]
| | | - choose -
| | | | pcTolerance 0-2
| | | | @um [Optional]
| | | - or -
| | | | tolerance 0-2
| | | | @um [Required]
| | | - end choose -
| | | qty 1-2
| | | @um [Required]
| | | deliveryDate 1-1
| | | @dateForm [Optional]
| | | notBeforeDate 0-1
| | | @dateForm [Optional]
| | | thirdParty 0-3 (AP)
| | | @VAT [Optional]
| | | @role [Required]
| | | @sender [Optional] (a*)
| | | | id 1-1
| | | | @numberingOrg [Optional]
| | | | legalName 0-1 (U)
| | | | dept 0-1
| | | | subDept 0-1 (N)
| | | | person 0-1
| | | | @email [Optional]
| | | | @phone [Optional]
| | | | @fax [Optional]
| | | | street 0-1
| | | | city 0-1
| | | | subCountry 0-1
| | | | country 0-1
| | | | postCode 0-1
| | | rawMnfrOperation 1-9 (P)
| | | - choose -
| | | | rawJob 1-1
| | | - or -
| | | | jobName 1-1
| | | - end choose -
| | | | refDoc 0-9 (P)
| | | | @docType [Required]
| | | | | docID 1-2
| | | | | @numberingOrg [Optional]
| | | | | docDate 0-1
| | | | | @dateForm [Optional]
| | | | | season 0-1 (A)
| | | | | @numberingOrg [Optional] (a)
| | | | | @codeList [Optional] (a)
| | | | | @listName [Optional] (a)
| | | | | @listVersion [Optional] (a)

```



```

| | | | | itemID 0-1 (U)
| | | | | attachment 0-1 (N)
| | | | | @uid [Optional]
| | | | | | fileName 0-1 (N)
| | | | | | | @numberingOrg [Optional] (a)
| | | | | | binaryObject 0-1 (N)
| | | | | | | @format [Optional] (Na)
| | | | | | | @mime [Optional] (Na)
| | | | | | | @encoding [Optional] (Na)
| | | | | | | @characterSet [Optional] (Na)
| | | | | | externalReference 0-99 (N)
| | | | | | | uri 1-1 (N)
| | | | | | | | @isURL [Optional] [Default= true] (Na)
| | | | | | | mimeCode 0-1 (N)
| | | | | | | formatCode 0-1 (N)
| | | | | | | encodingCode 0-1 (N)
| | | | | | | characterSetCode 0-1 (N)
| | | | | note 0-99
| | | | | | @numberingOrg [Optional]
| | | | | | @codeList [Optional]
| | | | | | @noteLabel [Optional]
| | | | | note 0-99
| | | | | | @numberingOrg [Optional]
| | | | | | @codeList [Optional]
| | | | | | @noteLabel [Optional]

```

## 2.2 Detailed description of document elements

Following tables show all elements (complex and simple) used in this document. Description includes: 1) element's information: xml tag, name, brief description, data type and syntax constraints; 2) information about use of the element in a particular position in the document: xpath and possible associated notes.

### 2.2.1 Complex elements (Aggregate Business Information Entities)

Complex elements are those elements whose content is composed of other elements (childs). Complex elements are alphabetically ordered.

<b>allowanceCharge</b>	Allowances and Charges related to an Order or a contract (XPath RAWDyeRequest/terms/allowanceCharge) 0-9 (A)
<b>attachment</b>	an attached document. An attachment can refer to an external document or be included with the document being exchanged (XPath RAWDyeRequest/RQheader/refDoc/attachment) 0-1 (N) (XPath RAWDyeRequest/RDRQbody/RDRQitem/rawMnfrOperation/refDoc/attachment) 0-1 (N)
<b>buyer</b>	details of the Buyer (party that buys the good or service that is object of the current collaborative process) - base type: Nad, (XPath RAWDyeRequest/RQheader/buyer) 1-1 (AP)
<b>dtScheme</b>	set of data usable to declare the duty or tax applied (XPath RAWDyeRequest/terms/allowanceCharge/dtScheme) 0-1 (P)
<b>externalReference</b>	details about an external object, such as a document stored at a remote location (XPath RAWDyeRequest/RQheader/refDoc/attachment/externalReference) 0-99 (N) (XPath RAWDyeRequest/RDRQbody/RDRQitem/rawMnfrOperation/refDoc/attachment/externalReference) 0-99 (N)
<b>insPayment</b>	payment details for payment by installments (XPath RAWDyeRequest/terms/insPayment) 0-5 - note: <i>excluded the case of offers, this set of data is alternative to payment set and must be iterated for each payment installment</i>
<b>payment</b>	payment details for payment all in one (XPath RAWDyeRequest/terms/payment) 0-5 - note: <i>excluded the case of offers, this set of data is alternative to insPayment, it can be iterated to specify alternative terms of payment (e.g.: 60 days or 30 days with 3% discount)</i>
<b>rawMnfrOperation</b>	details of a manufacturing operation on raw material used for manufacturing a yarn product (XPath RAWDyeRequest/RDRQbody/RDRQitem/rawMnfrOperation) 1-9 (P)
<b>rawSpecs</b>	technical characteristics of a raw material linked to an operation of the sub-contracted production of yarn or to the purchase of yarn (XPath RAWDyeRequest/RDRQbody/RDRQitem/rawSpecs) 0-9
<b>RDRQbody</b>	body of the document REQUEST FOR DYEING OF RAW MATERIAL (XPath RAWDyeRequest/RDRQbody) 1-1
<b>RDRQitem</b>	line of the document REQUEST FOR DYEING OF RAW MATERIAL (XPath RAWDyeRequest/RDRQbody/RDRQitem) 1-unbounded (P)
<b>refDoc</b>	identification of a document and of an item thereof, to which the message makes reference (XPath RAWDyeRequest/RDRQbody/RDRQitem/rawMnfrOperation/refDoc) 0-9 (P) (XPath RAWDyeRequest/RQheader/refDoc) 0-9 (P)

<b>RQheader</b>	header of the document REQUEST FOR OFFER (XPath RAWDyeRequest/RQheader) 1-1 (P)
<b>subContractor</b>	details of the Sub-contractor - base type: Nad, (XPath RAWDyeRequest/RQheader/subContractor) 0-1 (AP) - note: <i>At least one out of Supplier and Subcontractor must be indicated.</i>
<b>supplier</b>	details of the Supplier (party that supplies the good or service that is object of the current collaborative process) - base type: Nad, (XPath RAWDyeRequest/RQheader/supplier) 0-1 (AP) - note: <i>At least one out of Supplier and Subcontractor must be indicated.</i>
<b>terms</b>	details of the commercial obligations for payment and delivery (XPath RAWDyeRequest/terms) 0-1 (P)
<b>thirdParty</b>	details of the Third Party, different from Sender and Receiver of the document - base type: Nad, (XPath RAWDyeRequest/RQheader/thirdParty) 0-5 (AP) - note: <i>In the Offer Request case it might give reference to the Originator of the request.</i> (XPath RAWDyeRequest/RDRQbody/RDRQitem/thirdParty) 0-3 (AP)
<b>trade</b>	general terms of trade for the specified supply (XPath RAWDyeRequest/terms/trade) 0-1
<b>transInfo</b>	details of transport: mode, carrier and delivery place (XPath RAWDyeRequest/terms/transInfo) 0-5 (pAP)

## 2.2.2 Simple elements (Basic Business Information Entities)

Simple elements are those elements whose content is characterized by a data type plus a domain of possible values. Simple elements are alphabetically ordered.

AC_amount	amount of an Allowance or Charge - base type: decimal, fraction digits: 2, (XPath RAWDyeRequest/terms/allowanceCharge/AC_amount) 1-1 (A)
AC_category	coded specification of an Allowance or Charge - base type: string, cod. table: T41 <a href="http://www.ebiz.enea.it/moda-ml/repository/codelist/v2018-1/gc_T41.xml">http://www.ebiz.enea.it/moda-ml/repository/codelist/v2018-1/gc_T41.xml</a> (XPath RAWDyeRequest/terms/allowanceCharge/AC_category) 1-1
AC_categoryText	free text description of an Allowance or Charge - base type: string, max length: 250, (XPath RAWDyeRequest/terms/allowanceCharge/AC_categoryText) 1-1 (U)
AC_percent	amount of an Allowance or Charge as a percentage (always non negative value) - base type: decimal, max inclusive: 100, fraction digits: 2, (XPath RAWDyeRequest/terms/allowanceCharge/AC_percent) 1-1
additionalIdentifier	additional identification code of a Party, for example customs registries or others - base type: string, max length: 15, (XPath RAWDyeRequest/RQheader/supplier/additionalIdentifier) 0-9 (N) - note: <i>identifiers for example for exports, such as MID (Manufacturer Identification Code), EORI (E.O.R.I. - Economic Operator Registration and Identification)</i> (XPath RAWDyeRequest/RQheader/buyer/additionalIdentifier) 0-9 (N)

	- note: <i>identifiers for example for exports, such as MID (Manufacturer Identification Code), EORI (E.O.R.I. - Economic Operator Registration and Identification)</i>
@application	force or similar condition (e.g. no. of revolutions) applied in a test as specified within the standard - base type: string, max length: 15, (XPath RAWDyeRequest/RDRQbody/RDRQitem/rawSpecs/specValue/@application) [Optional]
binaryObject	a binary large object containing an attached document, Coding 'base64Binary' is recommended. - base type: base64Binary, (XPath RAWDyeRequest/RDRQbody/RDRQitem/rawMnfrOperation/refDoc/attachment/binaryObject) 0-1 (N) (XPath RAWDyeRequest/RQheader/refDoc/attachment/binaryObject) 0-1 (N)
carrier	identification of the transport carrier - base type: string, max length: 40, (XPath RAWDyeRequest/terms/transInfo/carrier) 0-1
@characterSet	the character set of the binary object (examples UTF-8, UTF-16, Windows-1252, ISO-8859-7,..) - base type: normalizedString, (XPath RAWDyeRequest/RDRQbody/RDRQitem/rawMnfrOperation/refDoc/attachment/binaryObject/@characterSet) [Optional] (Na) (XPath RAWDyeRequest/RQheader/refDoc/attachment/binaryObject/@characterSet) [Optional] (N)
characterSetCode	the character set of an external document (examples UTF-8, UTF-16, Windows-1252, ISO-8859-7,..) - base type: normalizedString, (XPath RAWDyeRequest/RDRQbody/RDRQitem/rawMnfrOperation/refDoc/attachment/externalReference/characterSetCode) 0-1 (N) (XPath RAWDyeRequest/RQheader/refDoc/attachment/externalReference/characterSetCode) 0-1 (N)
city	name of the city (town, village) - base type: string, max length: 40, (XPath RAWDyeRequest/RDRQbody/RDRQitem/thirdParty/city) 0-1 (XPath RAWDyeRequest/RQheader/supplier/city) 0-1 (XPath RAWDyeRequest/RQheader/subContractor/city) 0-1 (XPath RAWDyeRequest/RQheader/thirdParty/city) 0-1 (XPath RAWDyeRequest/RQheader/buyer/city) 0-1
@codeList	it specifies the URL where the list of codes used to make an instance of the element can be found - base type: string, max length: 255, (XPath RAWDyeRequest/RDRQbody/RDRQitem/note/@codeList) [Optional] - nota: <i>must be used to provide (URL) the list of codes used in "noteLabel"</i> (XPath RAWDyeRequest/terms/allowanceCharge/dtScheme/legalRef/@codeList) [Optional] (XPath RAWDyeRequest/RQheader/season/@codeList) [Optional] (a) - nota: <i>this attribute should be used either single or coupled with "listName" and "listVersion"</i> (XPath RAWDyeRequest/terms/allowanceCharge/dtScheme/note/@codeList) [Optional] - nota: <i>must be used to provide (URL) the list of codes used in "noteLabel"</i> (XPath RAWDyeRequest/RDRQbody/RDRQitem/rawMnfrOperation/note/@codeList) [Optional] - nota: <i>must be used to provide (URL) the list of codes used in "noteLabel"</i> (XPath RAWDyeRequest/RQheader/note/@codeList) [Optional] - nota: <i>must be used to provide (URL) the list of codes used in "noteLabel"</i> (XPath RAWDyeRequest/RDRQbody/RDRQitem/rawMnfrOperation/refDoc/season/@codeList) [Optional] (a)

	<p>- nota: <i>this attribute should be used either single or coupled with "listName" and "listVersion"</i>  (XPath RAWDyeRequest/RQheader/refDoc/season/@codeList) [Optional] (a)</p> <p>- nota: <i>this attribute should be used either single or coupled with "listName" and "listVersion"</i></p>
country	<p>code of the nation  - base type: string, cod. table: T10  <a href="http://www.ebiz.enea.it/moda-ml/repository/codelist/v2018-1/gc_T10.xml">http://www.ebiz.enea.it/moda-ml/repository/codelist/v2018-1/gc_T10.xml</a>  (XPath RAWDyeRequest/RQheader/supplier/country) 0-1  (XPath RAWDyeRequest/RQheader/subContractor/country) 0-1  (XPath RAWDyeRequest/RQheader/buyer/country) 0-1  (XPath RAWDyeRequest/RDRQbody/RDRQitem/thirdParty/country) 0-1  (XPath RAWDyeRequest/RQheader/thirdParty/country) 0-1</p>
@currency	<p>currency in which a specified monetary data is expressed  - base type: string, cod. table: T9  <a href="http://www.ebiz.enea.it/moda-ml/repository/codelist/v2018-1/gc_T9.xml">http://www.ebiz.enea.it/moda-ml/repository/codelist/v2018-1/gc_T9.xml</a>  (XPath RAWDyeRequest/terms/allowanceCharge/@currency) [Optional] (a)  (XPath RAWDyeRequest/terms/allowanceCharge/AC_amount/@currency) [Optional] (a)</p>
@CV	<p>coefficient of variation (CV) of a measurement  - base type: decimal,  (XPath RAWDyeRequest/RDRQbody/RDRQitem/rawSpecs/specValue/@CV) [Optional]</p>
@dateForm	<p>format used for the date  - base type: string, cod. table: NT29  <a href="http://www.ebiz.enea.it/moda-ml/repository/codelist/v2018-1/gc_NT29.xml">http://www.ebiz.enea.it/moda-ml/repository/codelist/v2018-1/gc_NT29.xml</a>  (XPath RAWDyeRequest/terms/transInfo/delEffectiveDate/@dateForm) [Optional]  (XPath RAWDyeRequest/RQheader/msgDate/@dateForm) [Optional]  (XPath RAWDyeRequest/RQheader/validityStart/@dateForm) [Optional]  (XPath RAWDyeRequest/terms/transInfo/despatchDate/@dateForm) [Optional] (a)  (XPath RAWDyeRequest/RDRQbody/RDRQitem/notBeforeDate/@dateForm) [Optional]  (XPath RAWDyeRequest/RDRQbody/RDRQitem/rawMnfrOperation/refDoc/docDate/@dateForm) [Optional]  (XPath RAWDyeRequest/RQheader/refDoc/docDate/@dateForm) [Optional]  (XPath RAWDyeRequest/RQheader/validityEnd/@dateForm) [Optional]  (XPath RAWDyeRequest/RDRQbody/RDRQitem/deliveryDate/@dateForm) [Optional]</p>
delEffectiveDate	<p>effective date of delivery of goods (declared in Despatch), according to one of the patterns YYYY-MM-DD, YYYY-MM-DD:HH-MM or YYYY-WW.  - base type: string,  (XPath RAWDyeRequest/terms/transInfo/delEffectiveDate) 0-1 (p)</p>
deliveryDate	<p>date of delivery of goods, requested or promised in the purchase process, according to one of the patterns YYYY-MM-DD, YYYY-MM-DD:HH-MM or YYYY-WW.  - base type: string,  (XPath RAWDyeRequest/RDRQbody/RDRQitem/deliveryDate) 1-1</p>
deliveryPlace	<p>place of delivery of goods, ultimate or related to a given leg  - base type: string, max length: 250,  (XPath RAWDyeRequest/terms/transInfo/deliveryPlace) 0-1 (U)</p>
dept	<p>name or code of a contact department within a Party  - base type: string, max length: 40,  (XPath RAWDyeRequest/RQheader/supplier/dept) 0-1  (XPath RAWDyeRequest/RQheader/subContractor/dept) 0-1  (XPath RAWDyeRequest/RQheader/thirdParty/dept) 0-1  (XPath RAWDyeRequest/RDRQbody/RDRQitem/thirdParty/dept) 0-1  (XPath RAWDyeRequest/RQheader/buyer/dept) 0-1</p>

despatchDate	date of despatch of goods, requested or promised in the purchase process, according to one of the patterns YYYY-MM-DD, YYYY-MM-DD:HH-MM or YYY-WW. - base type: string, (XPath RAWDyeRequest/terms/transInfo/despatchDate) 0-1 (N)
despatchPlace	place of despatch of goods, origin or related to a given leg - base type: string, max length: 250, (XPath RAWDyeRequest/terms/transInfo/despatchPlace) 0-1 (N)
docDate	date of issue of the referenced document, according to one of the patterns YYY-MM-DD, YYYY-MM-DD:HH-MM or YYYY-WW. - base type: string, (XPath RAWDyeRequest/RQheader/refDoc/docDate) 0-1 (XPath RAWDyeRequest/RDRQbody/RDRQitem/rawMnfrOperation/refDoc/docDate) 0-1
docID	identification number of the referenced document SINCE 2008-1 ITS USE I N THE HEADER IS DISCOURAGED (REPLACED BY msgID) - base type: string, max length: 80, (XPath RAWDyeRequest/RQheader/docID) 0-1 (XPath RAWDyeRequest/RQheader/refDoc/docID) 1-2 (p) <hr/> <b>AAAA-WARNING! - text not AVAILABLE n. 245 - In=en</b> (XPath RAWDyeRequest/RDRQbody/RDRQitem/rawMnfrOperation/refDoc/docID) 1-2 <hr/> <b>AAAA-WARNING! - text not AVAILABLE n. 245 - In=en</b>
@docType	type or class to which the referenced document belongs - base type: string, cod. table: T21 <a href="http://www.ebiz.enea.it/moda-ml/repository/codelist/v2018-1/gc_T21.xml">http://www.ebiz.enea.it/moda-ml/repository/codelist/v2018-1/gc_T21.xml</a> (XPath RAWDyeRequest/RQheader/refDoc/@docType) [Required] (XPath RAWDyeRequest/RDRQbody/RDRQitem/rawMnfrOperation/refDoc/@docType) [Required]
@email	electronic mail address of the contact person within a Party - base type: string, max length: 250, (XPath RAWDyeRequest/RDRQbody/RDRQitem/thirdParty/person/@email) [Optional] (XPath RAWDyeRequest/RQheader/supplier/person/@email) [Optional] (XPath RAWDyeRequest/RQheader/subContractor/person/@email) [Optional] (XPath RAWDyeRequest/RQheader/buyer/person/@email) [Optional] (XPath RAWDyeRequest/RQheader/thirdParty/person/@email) [Optional]
@encoding	specifies the decoding algorithm of the binary object - base type: normalizedString, (XPath RAWDyeRequest/RDRQbody/RDRQitem/rawMnfrOperation/refDoc/attachment/binaryObject/@encoding) [Optional] (Na) (XPath RAWDyeRequest/RQheader/refDoc/attachment/binaryObject/@encoding) [Optional] (N)
encodingCode	the encoding/decoding algorithm used with the external object (example is 'base64Binary') - base type: normalizedString, (XPath RAWDyeRequest/RQheader/refDoc/attachment/externalReference/encodingCode) 0-1 (N) (XPath RAWDyeRequest/RDRQbody/RDRQitem/rawMnfrOperation/refDoc/attachment/externalReference/encodingCode) 0-1 (N)
@fax	fax number of the contact person within a Party - base type: string, max length: 35, (XPath RAWDyeRequest/RDRQbody/RDRQitem/thirdParty/person/@fax) [Optional] (XPath RAWDyeRequest/RQheader/subContractor/person/@fax) [Optional] (XPath RAWDyeRequest/RQheader/thirdParty/person/@fax) [Optional] (XPath RAWDyeRequest/RQheader/buyer/person/@fax) [Optional] (XPath RAWDyeRequest/RQheader/supplier/person/@fax) [Optional]

fileName	unique identifier (name) of the file - base type: string, max length: 255, (XPath RAWDyeRequest/RDRQbody/RDRQitem/rawMnfrOperation/ refDoc/attachment/fileName) 0-1 (N) (XPath RAWDyeRequest/RQheader/refDoc/attachment/fileName) 0-1 (N)
@finDiscount	financial discount rate applied for payment by the date specified - base type: decimal, min inclusive: 0, max inclusive: 100, fraction digits: 2, (XPath RAWDyeRequest/terms/payment/@finDiscount) [Optional]
@finSurcharge	financial surcharge rate applied for payment after the date specified - base type: decimal, min inclusive: 0, max inclusive: 100, fraction digits: 2, (XPath RAWDyeRequest/terms/payment/@finSurcharge) [Optional]
@format	the format of the binary content (examples xml, pdf, doc,...) - base type: string, (XPath RAWDyeRequest/RQheader/refDoc/attachment/ binaryObject/@format) [Optional] (N) (XPath RAWDyeRequest/RDRQbody/RDRQitem/rawMnfrOperation/ refDoc/attachment/binaryObject/@format) [Optional] (Na)
formatCode	the format of the external object (examples xml, pdf, doc,...) - base type: normalizedString, (XPath RAWDyeRequest/RDRQbody/RDRQitem/rawMnfrOperation/ refDoc/attachment/externalReference/formatCode) 0-1 (N) (XPath RAWDyeRequest/RQheader/refDoc/attachment/ externalReference/formatCode) 0-1 (N)
grossWeight	the gross weight, declared for transport or customs purpose - base type: decimal, min inclusive: 0, fraction digits: 2, (XPath RAWDyeRequest/terms/transInfo/grossWeight) 0-1
id	primary identification code of a Party; it is recommended the format: nation code (ISO 3166) + VAT identification number (11 crt), with the qualifier "numberingOrg"= MF - base type: string, max length: 15, (XPath RAWDyeRequest/RDRQbody/RDRQitem/thirdParty/id) 1-1 (XPath RAWDyeRequest/RQheader/thirdParty/id) 1-1 (XPath RAWDyeRequest/RQheader/buyer/id) 1-1 (p) (XPath RAWDyeRequest/RQheader/subContractor/id) 1-1 (XPath RAWDyeRequest/RQheader/supplier/id) 1-1
@idQualifier	Qualification of the identifier. - base type: string, (XPath RAWDyeRequest/RQheader/buyer/additionalIdentifier/@idQualifier) [Optional] (Na) - nota: <i>this attribute should be used when the numberingOrg attribute is not enough to declare the type of identifier</i> (XPath RAWDyeRequest/RQheader/supplier/additionalIdentifier/@idQualifier) [Optional] (Na) - nota: <i>this attribute should be used when the numberingOrg attribute is not enough to declare the type of identifier</i>
incoTerm	specification of the terms of trade (INCOTERMS) - base type: string, cod. table: T3 <a href="http://www.ebiz.enea.it/moda-ml/repository/codelist/v2018-1/gc_T3.xml">http://www.ebiz.enea.it/moda-ml/repository/codelist/v2018-1/gc_T3.xml</a> (XPath RAWDyeRequest/terms/trade/incoTerm) 1-1
incoTermText	free text specifying the terms of trade (incoterm, location) - base type: string, max length: 250, (XPath RAWDyeRequest/terms/trade/incoTermText) 1-1 (U)
@isCharge	Indicates if the element to which it refers is a charge (true = charge, false = allowance) - base type: boolean, min length: 0, (XPath RAWDyeRequest/terms/allowanceCharge/@isCharge) [Optional] (N)

@isURL	<p>it indicates if the referred element is an URL (true) or not (false)</p> <p>- base type: boolean,  (XPath RAWDyeRequest/RDRQbody/RDRQitem/rawMnfrOperation/  refDoc/attachment/externalReference/uri/@isURL) [Optional] [Default= true] (Na)</p> <p>- nota: <i>usage of URLs is recommended</i>  (XPath RAWDyeRequest/RQheader/refDoc/attachment/  externalReference/uri/@isURL) [Optional] [Default= true] (Na)</p> <p>- nota: <i>usage of URLs is recommended</i></p>
itemID	<p>number of the line/item of the referenced document</p> <p>- base type: string, max length: 40,  (XPath RAWDyeRequest/RDRQbody/RDRQitem/rawMnfrOperation/  refDoc/itemID) 0-1 (U)</p> <p>(XPath RAWDyeRequest/RQheader/refDoc/itemID) 0-1 (U)</p>
jobName	<p>description of the elementary job</p> <p>- base type: string, max length: 40,  (XPath RAWDyeRequest/RDRQbody/RDRQitem/rawMnfrOperation/jobName) 1-1</p>
legalName	<p>legal name of a Party</p> <p>- base type: string, max length: 250,  (XPath RAWDyeRequest/RDRQbody/RDRQitem/thirdParty/legalName) 0-1 (U)</p> <p>(XPath RAWDyeRequest/RQheader/subContractor/legalName) 0-1 (U)</p> <p>(XPath RAWDyeRequest/RQheader/thirdParty/legalName) 0-1 (U)</p> <p>(XPath RAWDyeRequest/RQheader/supplier/legalName) 0-1 (U)</p> <p>(XPath RAWDyeRequest/RQheader/buyer/legalName) 0-1 (U)</p>
legalRef	<p>legal reference of the duty or tax or fee category</p> <p>- base type: string,  (XPath RAWDyeRequest/terms/allowanceCharge/dtScheme/legalRef) 0-1 (A)</p>
lineN	<p>number of the line item of the present message (xml document); it is set by the role that produces the document. Usually it is a progressive number, but not always.</p> <p>- base type: positiveInteger, min inclusive: 1, max inclusive: 9999,  (XPath RAWDyeRequest/RDRQbody/RDRQitem/lineN) 1-1</p>
@listName	<p>the name of the list of codes used to make an instance of the element (it might be thought as descriptive element, i.e. 'fabric printing technologies', or not, i.e. "T264")</p> <p>- base type: string, max length: 40,  (XPath RAWDyeRequest/terms/allowanceCharge/dtScheme/  legalRef/@listName) [Optional]</p> <p>- nota: <i>this attribute should always be used coupled with "numberingOrg"</i>  (XPath RAWDyeRequest/RQheader/season/@listName) [Optional] (a)</p> <p>- nota: <i>this attribute should always be used coupled with "numberingOrg"</i>  (XPath RAWDyeRequest/RDRQbody/RDRQitem/rawMnfrOperation/  refDoc/season/@listName) [Optional] (a)</p> <p>- nota: <i>this attribute should always be used coupled with "numberingOrg"</i>  (XPath RAWDyeRequest/RQheader/refDoc/season/@listName) [Optional] (a)</p> <p>- nota: <i>this attribute should always be used coupled with "numberingOrg"</i></p>
@listVersion	<p>it specifies the version of the list of codes used to make an instance of the element</p> <p>- base type: string, max length: 6,  (XPath RAWDyeRequest/terms/allowanceCharge/dtScheme/  legalRef/@listVersion) [Optional]</p> <p>- nota: <i>this attribute should always be used coupled with "numberingOrg" and "listName"</i>  (XPath RAWDyeRequest/RQheader/season/@listVersion) [Optional] (a)</p> <p>- nota: <i>this attribute should always be used coupled with "numberingOrg" and "listName"</i>  (XPath RAWDyeRequest/RDRQbody/RDRQitem/rawMnfrOperation/  refDoc/season/@listVersion) [Optional] (a)</p>



	<p>- nota: <i>this attribute should always be used coupled with “numberingOrg” and “listName”</i>  (XPath RAWDyeRequest/RQheader/refDoc/season/@listVersion) [Optional] (a)</p> <p>- nota: <i>this attribute should always be used coupled with “numberingOrg” and “listName”</i></p>
location	<p>specification of a location</p> <p>- base type: string, max length: 40,  (XPath RAWDyeRequest/terms/trade/location) 0-1</p> <p>- note: <i>place to which the INCOTERM applies</i></p>
@logo	<p>company logo (URL of the image jpeg or gif). It is recommended that the width of the image does not exceed 640 pixel.</p> <p>- base type: string, max length: 255,  (XPath RAWDyeRequest/RQheader/supplier/@logo) [Optional]  (XPath RAWDyeRequest/RQheader/buyer/@logo) [Optional]</p>
@LRI	<p>attribute usable to format a string according to a customized User rule (local rule)</p> <p>- base type: string, cod. table: NT3  <a href="http://www.ebiz.enea.it/moda-ml/repository/codelist/v2018-1/gc_NT3.xml">http://www.ebiz.enea.it/moda-ml/repository/codelist/v2018-1/gc_NT3.xml</a>  (XPath RAWDyeRequest/terms/trade/location/@LRI) [Optional]</p>
@maxQty	<p>maximum product quantity</p> <p>- base type: decimal, min inclusive: 0, fraction digits: 2,  (XPath RAWDyeRequest/terms/allowanceCharge/@maxQty) [Optional] (N)</p> <p>- nota: <i>maximum quantity of product for the application of this allowance or charge</i></p>
@method	<p>standard protocol or method employed in a test to evaluate a characteristic or a parameter</p> <p>- base type: string, max length: 80,  (XPath RAWDyeRequest/RDRQbody/RDRQitem/rawSpecs/specValue/@method) [Optional]</p>
@mime	<p>the mime type of the binary object</p> <p>- base type: normalizedString,  (XPath RAWDyeRequest/RQheader/refDoc/attachment/binaryObject/@mime) [Optional] (N)  (XPath RAWDyeRequest/RDRQbody/RDRQitem/rawMnfrOperation/refDoc/attachment/binaryObject/@mime) [Optional] (Na)</p>
mimeCode	<p>mime type of the external object</p> <p>- base type: normalizedString,  (XPath RAWDyeRequest/RQheader/refDoc/attachment/externalReference/mimeCode) 0-1 (N)</p> <hr/> <p><b>AAAA-WARNING! - text not AVAILABLE n. 245 - In=en</b>  (XPath RAWDyeRequest/RDRQbody/RDRQitem/rawMnfrOperation/refDoc/attachment/externalReference/mimeCode) 0-1 (N)</p> <hr/> <p><b>AAAA-WARNING! - text not AVAILABLE n. 245 - In=en</b></p>
@minQty	<p>minimum product quantity</p> <p>- base type: decimal, min inclusive: 0, fraction digits: 2,  (XPath RAWDyeRequest/terms/allowanceCharge/@minQty) [Optional] (a)</p> <p>- nota: <i>minimum quantity of product for the application of this allowance or charge</i></p>
msgDate	<p>date of issue of the present message (xml document), according to one of the patterns YYYY-MM-DD, YYYY-MM-DD:HH-MM or YYYY-WW.</p> <p>- base type: string,  (XPath RAWDyeRequest/RQheader/msgDate) 1-1</p>
@msgfunction	<p>function performed by the present message with regards to the transmission</p> <p>- base type: string, cod. table: NT18  <a href="http://www.ebiz.enea.it/moda-ml/repository/codelist/v2018-1/gc_NT18.xml">http://www.ebiz.enea.it/moda-ml/repository/codelist/v2018-1/gc_NT18.xml</a></p>

	(XPath RAWDyeRequest/@msgfunction) [Optional] [Default= OR]
msgID	key identifier of the business document in the information system of the issuing Party. In case of more despatches of the same business document, it is unchanged. - base type: string, max length: 35, (XPath RAWDyeRequest/RQheader/msgID) 0-1
msgN	identification number given to the message (xml document) by its issuer. In case of more despatches of the same business document, it changes. - base type: string, max length: 35, (XPath RAWDyeRequest/RQheader/msgN) 1-1
netWeight	the net weight declared for transport or customs purpose - base type: decimal, min inclusive: 0, fraction digits: 2, (XPath RAWDyeRequest/terms/transInfo/netWeight) 0-1
notBeforeDate	earliest date possible to begin an activity, according to one of the patterns YYYY-MM-DD, YYYY-MM-DD:HH-MM or YYYY-WW. - base type: string, (XPath RAWDyeRequest/RDRQbody/RDRQitem/notBeforeDate) 0-1
note	free text or structured (computer processing) note. For note structuring use the attributes "noteLabel" and "codelist" - base type: string, max length: 350, (XPath RAWDyeRequest/terms/allowanceCharge/dtScheme/note) 0-99 (XPath RAWDyeRequest/RQheader/note) 0-99 (XPath RAWDyeRequest/RDRQbody/RDRQitem/note) 0-99 (XPath RAWDyeRequest/RDRQbody/RDRQitem/rawMnfrOperation/note) 0-99
@noteLabel	subject qualifier of a note - base type: string, max length: 35, (XPath RAWDyeRequest/RDRQbody/RDRQitem/rawMnfrOperation/note/@noteLabel) [Optional] - nota: <i>must be used to qualify the subject of the note</i> (XPath RAWDyeRequest/RDRQbody/RDRQitem/note/@noteLabel) [Optional] - nota: <i>must be used to qualify the subject of the note</i> (XPath RAWDyeRequest/terms/allowanceCharge/dtScheme/note/@noteLabel) [Optional] - nota: <i>must be used to qualify the subject of the note</i> (XPath RAWDyeRequest/RQheader/note/@noteLabel) [Optional] - nota: <i>must be used to qualify the subject of the note</i>
@numberingOrg	code specifying the organisation who has created or owns the coding or numbering system - base type: string, cod. table: NT6 <a href="http://www.ebiz.enea.it/moda-ml/repository/codelist/v2018-1/gc_NT6.xml">http://www.ebiz.enea.it/moda-ml/repository/codelist/v2018-1/gc_NT6.xml</a> (XPath RAWDyeRequest/RQheader/docID/@numberingOrg) [Optional] - nota: <i>here can be specified whose document numbering is used (e.g.: Client, Supplier, ..)</i> (XPath RAWDyeRequest/RQheader/refDoc/season/@numberingOrg) [Optional] (a) - nota: <i>this attribute should be used either single or coupled with "listName" and "listVersion"</i> (XPath RAWDyeRequest/RQheader/refDoc/docID/@numberingOrg) [Optional] - nota: <i>here can be specified whose document numbering is used (e.g.: Client, Supplier, ..)</i> (XPath RAWDyeRequest/RDRQbody/RDRQitem/note/@numberingOrg) [Optional] - nota: <i>must be used to specify the organization that created the list of codes used in "noteLabel"</i> (XPath RAWDyeRequest/terms/allowanceCharge/dtScheme/legalRef/@numberingOrg) [Optional] - nota: <i>this attribute should be used either single or coupled with "listName" and "listVersion"</i> (XPath RAWDyeRequest/RQheader/season/@numberingOrg) [Optional] (a)

	<p>- nota: <i>this attribute should be used either single or coupled with "listName" and "listVersion"</i>  (XPath RAWDyeRequest/terms/allowanceCharge/dtScheme/note/@numberingOrg) [Optional]</p> <p>- nota: <i>must be used to specify the organization that created the list of codes used in "noteLabel"</i>  (XPath RAWDyeRequest/RDRQbody/RDRQitem/rawMnfrOperation/refDoc/docID/@numberingOrg) [Optional]</p> <p>- nota: <i>here can be specified whose document numbering is used (e.g.: Client, Supplier, ..)</i>  (XPath RAWDyeRequest/RDRQbody/RDRQitem/rawMnfrOperation/refDoc/season/@numberingOrg) [Optional] (a)</p> <p>- nota: <i>this attribute should be used either single or coupled with "listName" and "listVersion"</i>  (XPath RAWDyeRequest/RQheader/subContractor/id/@numberingOrg) [Optional]  (XPath RAWDyeRequest/RDRQbody/RDRQitem/thirdParty/id/@numberingOrg) [Optional]</p> <p>(XPath RAWDyeRequest/RQheader/note/@numberingOrg) [Optional]</p> <p>- nota: <i>must be used to specify the organization that created the list of codes used in "noteLabel"</i>  (XPath RAWDyeRequest/RQheader/thirdParty/id/@numberingOrg) [Optional]  (XPath RAWDyeRequest/RDRQbody/RDRQitem/rawMnfrOperation/refDoc/attachment/fileName/@numberingOrg) [Optional] (a)  (XPath RAWDyeRequest/RQheader/buyer/id/@numberingOrg) [Optional]  (XPath RAWDyeRequest/RDRQbody/RDRQitem/rawMnfrOperation/note/@numberingOrg) [Optional]</p> <p>- nota: <i>must be used to specify the organization that created the list of codes used in "noteLabel"</i>  (XPath RAWDyeRequest/RQheader/refDoc/attachment/fileName/@numberingOrg) [Optional] (a)  (XPath  RAWDyeRequest/RQheader/supplier/additionalIdentifier/@numberingOrg) [Optional] (a)</p> <p>- nota: <i>here the issuer of the identifier must be specified</i>  (XPath RAWDyeRequest/RQheader/supplier/id/@numberingOrg) [Optional]  (XPath RAWDyeRequest/RQheader/buyer/additionalIdentifier/@numberingOrg) [Optional] (a)</p> <p>- nota: <i>here the issuer of the identifier must be specified</i></p>
@part	<p>percent fraction of a total payment  - base type: decimal, min inclusive: 1, max inclusive: 99, fraction digits: 2,  (XPath RAWDyeRequest/terms/insPayment/@part) [Required]  - nota: <i>here the % value of each installment must be indicated</i></p>
payMode	<p>way or means of payment  - base type: string, cod. table: T2  <a href="http://www.ebiz.enea.it/moda-ml/repository/codelist/v2018-1/gc_T2.xml">http://www.ebiz.enea.it/moda-ml/repository/codelist/v2018-1/gc_T2.xml</a>  (XPath RAWDyeRequest/terms/payment/payMode) 0-1  (XPath RAWDyeRequest/terms/insPayment/payMode) 0-1</p>
payTerm	<p>code specifying the terms or time by which the payment must be done  - base type: string, cod. table: T1  <a href="http://www.ebiz.enea.it/moda-ml/repository/codelist/v2018-1/gc_T1.xml">http://www.ebiz.enea.it/moda-ml/repository/codelist/v2018-1/gc_T1.xml</a>  (XPath RAWDyeRequest/terms/payment/payTerm) 1-1  (XPath RAWDyeRequest/terms/insPayment/payTerm) 1-1</p>
payTermText	<p>free text specifying the terms by which the payment must be done (time/mode or means)  - base type: string, max length: 250,  (XPath RAWDyeRequest/terms/insPayment/payTermText) 1-1 (U)  (XPath RAWDyeRequest/terms/payment/payTermText) 1-1 (U)</p>
pcTolerance	<p>percent deviation tolerated on the value of a measurement (it must have a plus or minus sign)  - base type: decimal, min inclusive: 0, max inclusive: 100, total digits: 2,  (XPath RAWDyeRequest/RDRQbody/RDRQitem/rawSpecs/pcTolerance) 0-2</p>

person	<p>name of the contact person within a Party</p> <ul style="list-style-type: none"> <li>- base type: string, max length: 40,</li> <li>(XPath RAWDyeRequest/RQheader/buyer/person) 0-1</li> <li>(XPath RAWDyeRequest/RQheader/subContractor/person) 0-1</li> <li>(XPath RAWDyeRequest/RQheader/supplier/person) 0-1</li> <li>(XPath RAWDyeRequest/RQheader/thirdParty/person) 0-1</li> <li>(XPath RAWDyeRequest/RDRQbody/RDRQitem/thirdParty/person) 0-1</li> </ul>
@phone	<p>phone number of the contact person within a Party</p> <ul style="list-style-type: none"> <li>- base type: string, max length: 35,</li> <li>(XPath RAWDyeRequest/RQheader/thirdParty/person/@phone) [Optional]</li> <li>(XPath RAWDyeRequest/RQheader/subContractor/person/@phone) [Optional]</li> <li>(XPath RAWDyeRequest/RQheader/supplier/person/@phone) [Optional]</li> <li>(XPath RAWDyeRequest/RDRQbody/RDRQitem/thirdParty/person/@phone) [Optional]</li> <li>(XPath RAWDyeRequest/RQheader/buyer/person/@phone) [Optional]</li> </ul>
postCode	<p>code defining the postal zone</p> <ul style="list-style-type: none"> <li>- base type: string, max length: 10,</li> <li>(XPath RAWDyeRequest/RDRQbody/RDRQitem/thirdParty/postCode) 0-1</li> <li>(XPath RAWDyeRequest/RQheader/supplier/postCode) 0-1</li> <li>(XPath RAWDyeRequest/RQheader/subContractor/postCode) 0-1</li> <li>(XPath RAWDyeRequest/RQheader/buyer/postCode) 0-1</li> <li>(XPath RAWDyeRequest/RQheader/thirdParty/postCode) 0-1</li> </ul>
@progr	<p>progressive number in the sequence</p> <ul style="list-style-type: none"> <li>- base type: positiveInteger, min inclusive: 1,</li> <li>(XPath RAWDyeRequest/terms/transInfo/@progr) [Optional] (N)</li> <li>- nota: <i>Indicates the position of the leg in a sequence of transport legs. If it is declared it must be in all the transInfo elements.</i></li> </ul>
qty	<p>net quantity of the article or object correlated, qualified by the function of the document (ordering, delivering, ..) and by the context</p> <ul style="list-style-type: none"> <li>- base type: decimal, min inclusive: 0, fraction digits: 2,</li> <li>(XPath RAWDyeRequest/RDRQbody/RDRQitem/qty) 1-2</li> </ul> <hr/> <p>AAAA-WARNING! - text not AVAILABLE n. 245 - In=en</p>
rawChar	<p>physical or mechanical parameter used to define a characteristics of a raw material</p> <ul style="list-style-type: none"> <li>- base type: string, cod. table: T22</li> <li><a href="http://www.ebiz.enea.it/moda-ml/repository/codelist/v2018-1/gc_T22.xml">http://www.ebiz.enea.it/moda-ml/repository/codelist/v2018-1/gc_T22.xml</a></li> <li>(XPath RAWDyeRequest/RDRQbody/RDRQitem/rawSpecs/rawChar) 1-1</li> </ul>
rawCharText	<p>free text describing the physical or mechanical parameter used to define a characteristics of a raw material</p> <ul style="list-style-type: none"> <li>- base type: string, max length: 250,</li> <li>(XPath RAWDyeRequest/RDRQbody/RDRQitem/rawSpecs/rawCharText) 1-1 (U)</li> </ul>
rawJob	<p>operation of a work cycle for raw material</p> <ul style="list-style-type: none"> <li>- base type: string, cod. table: T200</li> <li><a href="http://www.ebiz.enea.it/moda-ml/repository/codelist/v2018-1/gc_T200.xml">http://www.ebiz.enea.it/moda-ml/repository/codelist/v2018-1/gc_T200.xml</a></li> <li>(XPath RAWDyeRequest/RDRQbody/RDRQitem/rawMnfrOperation/rawJob) 1-1</li> </ul>
@rawProcQualifier	<p>type of raw material with reference to the manufacturing process</p> <ul style="list-style-type: none"> <li>- base type: string, cod. table: NT30</li> <li><a href="http://www.ebiz.enea.it/moda-ml/repository/codelist/v2018-1/gc_NT30.xml">http://www.ebiz.enea.it/moda-ml/repository/codelist/v2018-1/gc_NT30.xml</a></li> <li>(XPath RAWDyeRequest/@rawProcQualifier) [Required]</li> </ul>
@role	<p>Third Party role qualifier</p> <ul style="list-style-type: none"> <li>- base type: string, cod. table: NT2</li> <li><a href="http://www.ebiz.enea.it/moda-ml/repository/codelist/v2018-1/gc_NT2.xml">http://www.ebiz.enea.it/moda-ml/repository/codelist/v2018-1/gc_NT2.xml</a></li> <li>(XPath RAWDyeRequest/RQheader/thirdParty/@role) [Required]</li> <li>(XPath RAWDyeRequest/RDRQbody/RDRQitem/thirdParty/@role) [Required]</li> </ul>
season	<p>sale season; defined as: season (1 crt) + year (4 crt) - season: S/S=1 A/W=2 Spring=3 Summer=4 Autumn=5 Winter=6: for more than four seasons use</p>

	<p>alphabetic sequence: 1st season=A 2nd season=B etc.etc.</p> <p>- base type: string, max length: 15, (XPath RAWDyeRequest/RQheader/refDoc/season) 0-1 (A)</p> <p>- note: <i>here indicates the season to which the referenced document belongs</i> (XPath RAWDyeRequest/RDRQbody/RDRQitem/rawMnfrOperation/refDoc/season) 0-1 (A)</p> <p>- note: <i>here indicates the season to which the referenced document belongs</i> (XPath RAWDyeRequest/RQheader/season) 0-1 (A)</p>
@sender	<p>qualifier that specifies the Party issuing of the document</p> <p>- base type: boolean, (XPath RAWDyeRequest/RQheader/subContractor/@sender) [Optional] (a*)</p> <p>- nota: <i>This attribute is mandatory when the STYLESHEET must be used</i> (XPath RAWDyeRequest/RQheader/buyer/@sender) [Optional] (a*)</p> <p>- nota: <i>This attribute is mandatory when the STYLESHEET must be used</i> (XPath RAWDyeRequest/RQheader/thirdParty/@sender) [Optional] (a*)</p> <p>- nota: <i>This attribute is mandatory when the STYLESHEET must be used</i> (XPath RAWDyeRequest/RQheader/supplier/@sender) [Optional] (a*)</p> <p>- nota: <i>This attribute is mandatory when the STYLESHEET must be used</i> (XPath RAWDyeRequest/RDRQbody/RDRQitem/thirdParty/@sender) [Optional] (a*)</p> <p>- nota: <i>This attribute is mandatory when the STYLESHEET must be used</i></p>
@source	<p>party who has provided the data</p> <p>- base type: string, cod. table: NT12 <a href="http://www.ebiz.enea.it/moda-ml/repository/codelist/v2018-1/gc_NT12.xml">http://www.ebiz.enea.it/moda-ml/repository/codelist/v2018-1/gc_NT12.xml</a> (XPath RAWDyeRequest/RDRQbody/RDRQitem/rawSpecs/specValue/@source) [Optional]</p>
specValue	<p>value requested for a property or a parameter that is measured</p> <p>- base type: decimal, (XPath RAWDyeRequest/RDRQbody/RDRQitem/rawSpecs/specValue) 0-1</p>
street	<p>street and building number identifying a location</p> <p>- base type: string, max length: 80, (XPath RAWDyeRequest/RQheader/thirdParty/street) 0-1 (XPath RAWDyeRequest/RQheader/subContractor/street) 0-1 (XPath RAWDyeRequest/RQheader/supplier/street) 0-1 (XPath RAWDyeRequest/RDRQbody/RDRQitem/thirdParty/street) 0-1 (XPath RAWDyeRequest/RQheader/buyer/street) 0-1</p>
subCountry	<p>short name or code of the sub-country entity</p> <p>- base type: string, max length: 9, (XPath RAWDyeRequest/RQheader/buyer/subCountry) 0-1 (XPath RAWDyeRequest/RQheader/subContractor/subCountry) 0-1 (XPath RAWDyeRequest/RQheader/supplier/subCountry) 0-1 (XPath RAWDyeRequest/RDRQbody/RDRQitem/thirdParty/subCountry) 0-1 (XPath RAWDyeRequest/RQheader/thirdParty/subCountry) 0-1</p>
subDept	<p>name or code of a contact department within a Party</p> <p>- base type: string, max length: 40, (XPath RAWDyeRequest/RQheader/subContractor/subDept) 0-1 (N) (XPath RAWDyeRequest/RQheader/buyer/subDept) 0-1 (N) (XPath RAWDyeRequest/RQheader/supplier/subDept) 0-1 (N) (XPath RAWDyeRequest/RQheader/thirdParty/subDept) 0-1 (N) (XPath RAWDyeRequest/RDRQbody/RDRQitem/thirdParty/subDept) 0-1 (N)</p>
taxCategory	<p>duty or tax or fee category</p> <p>- base type: string, cod. table: T62 <a href="http://www.ebiz.enea.it/moda-ml/repository/codelist/v2018-1/gc_T62.xml">http://www.ebiz.enea.it/moda-ml/repository/codelist/v2018-1/gc_T62.xml</a> (XPath RAWDyeRequest/terms/allowanceCharge/dtScheme/taxCategory) 0-1</p>
taxRate	<p>duty or tax or fee percent rate</p> <p>- base type: string, (XPath RAWDyeRequest/terms/allowanceCharge/dtScheme/taxRate) 0-1</p>

@taxType	duty or tax or fee type - base type: string, cod. table: T61 <a href="http://www.ebiz.enea.it/moda-ml/repository/codelist/v2018-1/gc_T61.xml">http://www.ebiz.enea.it/moda-ml/repository/codelist/v2018-1/gc_T61.xml</a> (XPath RAWDyeRequest/terms/allowanceCharge/dtScheme/@taxType) [Required]
tolerance	deviation tolerated on the value of a measurement (it must have a plus or minus sign) - base type: decimal, (XPath RAWDyeRequest/RDRQbody/RDRQitem/rawSpecs/tolerance) 0-2
transCondition	special condition of transport or special service requested to the Forwarder - base type: string, cod. table: T38 <a href="http://www.ebiz.enea.it/moda-ml/repository/codelist/v2018-1/gc_T38.xml">http://www.ebiz.enea.it/moda-ml/repository/codelist/v2018-1/gc_T38.xml</a> (XPath RAWDyeRequest/terms/transInfo/transCondition) 0-3
transConditionText	free text description of the special condition of transport or special service requested to the Forwarder - base type: string, max length: 250, (XPath RAWDyeRequest/terms/transInfo/transConditionText) 0-1 (U)
transMeans	means of transport, in general or referred to a specific leg - base type: string, cod. table: T40 <a href="http://www.ebiz.enea.it/moda-ml/repository/codelist/v2018-1/gc_T40.xml">http://www.ebiz.enea.it/moda-ml/repository/codelist/v2018-1/gc_T40.xml</a> (XPath RAWDyeRequest/terms/transInfo/transMeans) 0-1
transMode	way of transport, in general or referred to the specified leg - base type: string, cod. table: T8 <a href="http://www.ebiz.enea.it/moda-ml/repository/codelist/v2018-1/gc_T8.xml">http://www.ebiz.enea.it/moda-ml/repository/codelist/v2018-1/gc_T8.xml</a> (XPath RAWDyeRequest/terms/transInfo/transMode) 1-1
@transReason	reason for the transport - base type: string, cod. table: NT11 <a href="http://www.ebiz.enea.it/moda-ml/repository/codelist/v2018-1/gc_NT11.xml">http://www.ebiz.enea.it/moda-ml/repository/codelist/v2018-1/gc_NT11.xml</a> (XPath RAWDyeRequest/terms/transInfo/@transReason) [Optional]
@uid	unique element identifier within the xml document - base type: string, (XPath RAWDyeRequest/RDRQbody/RDRQitem/rawMnfrOperation/refDoc/attachment/@uid) [Optional] (XPath RAWDyeRequest/RQheader/refDoc/attachment/@uid) [Optional]
@um	specification of the unit of measure - base type: string, cod. table: NT7 <a href="http://www.ebiz.enea.it/moda-ml/repository/codelist/v2018-1/gc_NT7.xml">http://www.ebiz.enea.it/moda-ml/repository/codelist/v2018-1/gc_NT7.xml</a> (XPath RAWDyeRequest/RDRQbody/RDRQitem/rawSpecs/specValue/@um) [Optional] (XPath RAWDyeRequest/terms/allowanceCharge/@um) [Optional] (a) (XPath RAWDyeRequest/RDRQbody/RDRQitem/rawSpecs/pcTolerance/@um) [Optional] - nota: <i>to be used when it has to be soecified if the declared percentage is by weight, volume, etc...</i> (XPath RAWDyeRequest/RDRQbody/RDRQitem/qty/@um) [Required] (XPath RAWDyeRequest/RDRQbody/RDRQitem/rawSpecs/tolerance/@um) [Required] (XPath RAWDyeRequest/terms/transInfo/grossWeight/@um) [Required] (XPath RAWDyeRequest/terms/transInfo/netWeight/@um) [Required]
uri	Uniform Resource Identifier (URI) that identifies the external object as an Internet resource - base type: normalizedString, (XPath RAWDyeRequest/RQheader/refDoc/attachment/externalReference/uri) 1-1 (N) (XPath RAWDyeRequest/RDRQbody/RDRQitem/rawMnfrOperation/refDoc/attachment/externalReference/uri) 1-1 (N)
@useProfile	use profile to which the present document if compliant if it was agreed by the parties. It is suggested a URI with reference to the firms or the URL of the

	<p>profile.</p> <ul style="list-style-type: none"> <li>- base type: string,</li> </ul> <p>(XPath RAWDyeRequest/@useProfile) [Optional]</p>
validityEnd	<p>date by which the validity ends, according to one of the patterns YYYY-MM-DD, YYYY-MM-DD:HH-MM or YYYY-WW.</p> <ul style="list-style-type: none"> <li>- base type: string,</li> </ul> <p>(XPath RAWDyeRequest/RQheader/validityEnd) 1-1</p>
validityStart	<p>date by which the validity starts, according to one of the patterns YYYY-MM-DD, YYYY-MM-DD:HH-MM or YYYY-WW.</p> <ul style="list-style-type: none"> <li>- base type: string,</li> </ul> <p>(XPath RAWDyeRequest/RQheader/validityStart) 0-1</p>
@VAT	<p>VAT rate or code (DEPRECATED, use dtScheme element)</p> <ul style="list-style-type: none"> <li>- base type: string, cod. table: NT16</li> </ul> <p><a href="http://www.ebiz.enea.it/moda-ml/repository/codelist/v2018-1/gc_NT16.xml">http://www.ebiz.enea.it/moda-ml/repository/codelist/v2018-1/gc_NT16.xml</a></p> <p>(XPath RAWDyeRequest/RQheader/thirdParty/@VAT) [Optional]</p> <p>(XPath RAWDyeRequest/RDRQbody/RDRQitem/thirdParty/@VAT) [Optional]</p> <p>(XPath RAWDyeRequest/RDRQbody/RDRQitem/lineN/@VAT) [Optional]</p> <ul style="list-style-type: none"> <li>- nota: <i>Deprecated, prefer dtScheme when available.</i></li> </ul> <p>(XPath RAWDyeRequest/terms/allowanceCharge/@VAT) [Optional]</p>
@version	<p>Dictionary version from which the instance has been created</p> <ul style="list-style-type: none"> <li>- base type: string, cod. table: NT100</li> </ul> <p><a href="http://www.ebiz.enea.it/moda-ml/repository/codelist/v2018-1/gc_NT100.xml">http://www.ebiz.enea.it/moda-ml/repository/codelist/v2018-1/gc_NT100.xml</a></p> <p>(XPath RAWDyeRequest/@version) [Optional] [Default= 2018-1]</p>

## 2.3 Suggested best practices

**RAWDyeRequest/RQheader/refDoc/docID (identification number of the referenced document SINCE 2008-1 ITS USE IN THE HEADER IS DISCOURAGED (REPLACED BY msgID))**

numberingOrg indicates the role that produced the document identifier (it is allowed to declare two different ones -e.g. customer and supplier - with two docID with different numberingOrg

**RAWDyeRequest/RDRQbody/RDRQitem/rawMnfrOperation/**

**refDoc/docID (identification number of the referenced document SINCE 2008-1 ITS USE IN THE HEADER IS DISCOURAGED (REPLACED BY msgID))**

numberingOrg indicates the role that produced the document identifier (it is allowed to declare two different ones -e.g. customer and supplier - with two docID with different numberingOrg

**RAWDyeRequest/RQheader/refDoc/attachment/**

**externalReference/mimeType (mime type of the external object)**

Use coding from IANA <http://www.iana.org/assignments/media-types/media-types.xml>

**RAWDyeRequest/RDRQbody/RDRQitem/rawMnfrOperation/**

**refDoc/attachment/externalReference/mimeType (mime type of the external object)**

Use coding from IANA <http://www.iana.org/assignments/media-types/media-types.xml>

**RAWDyeRequest/RDRQbody/RDRQitem/qty (net quantity of the article or object correlated, qualified by the function of the document (ordering, delivering, ..) and by the context)**

this element can have two instances only if the units of measure are different



## 2.4 Enumeration tables

List of enumeration tables used in the XML document. You can find the corresponding codes at:  
<http://www.ebiz-tcf.eu/moda-ml/imple/moda-ml-2018-1.asp?lingua=en&pag=6>

### Legenda

- N: new table
- U: updated properties

NT100 - eBIZ TCFUpstream version  
NT11 - transport causal  
NT12 - data source  
NT16 - VAT rate or code  
NT18 - message function  
NT2 - third party qualifier  
NT29 - format of a date  
NT3 - data format  
NT30 - raw material family  
NT6 - coding system owner/issuer  
NT7 - unit of measure (U)  
T1 - terms of payment  
T10 - ISO3166 - Country  
T2 - Modes of payment  
T200 - type of job on raw material  
T21 - type of document  
T22 - raw material characteristics type  
T3 - terms of delivery  
T38 - transport conditions  
T40 - type of transport means  
T41 - type of Allowance or Charge  
T61 - duty or tax or fee type  
T62 - duty or tax or fee category  
T8 - Modes of Transport  
T9 - ISO4217 - Currency



# Annex A

Representative images of the principal complex elements' structure.

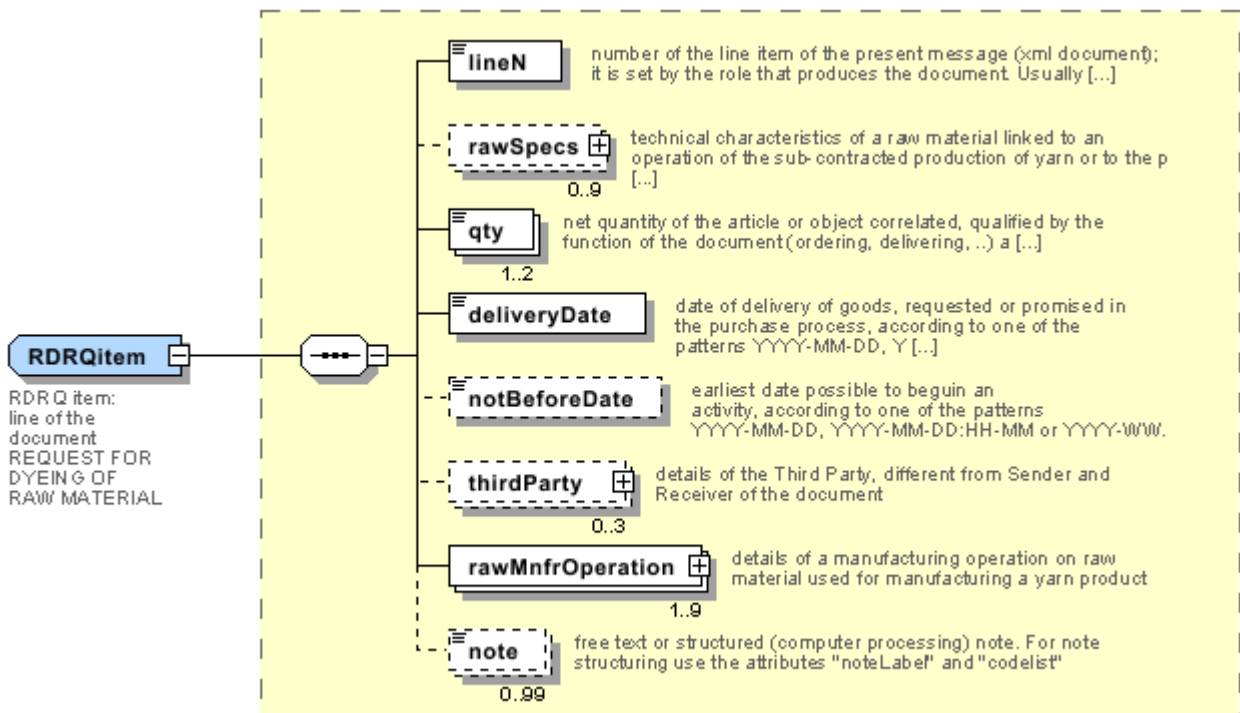
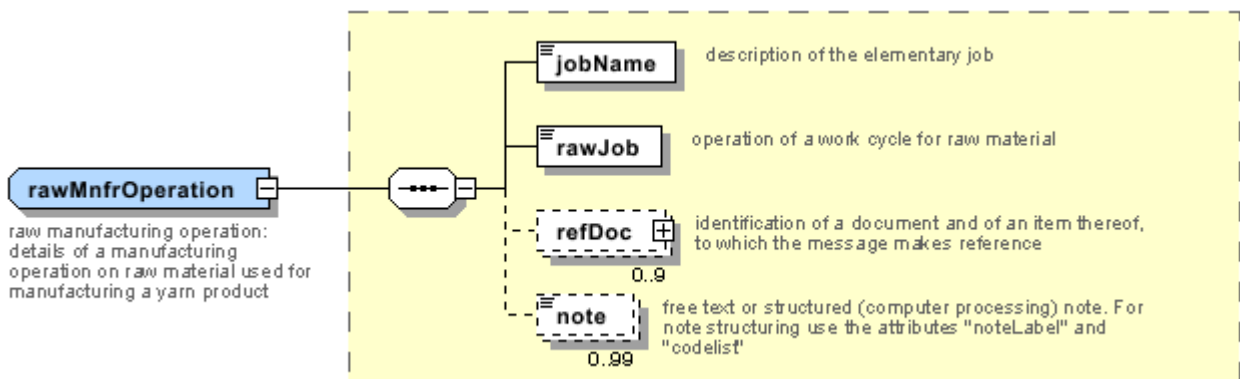
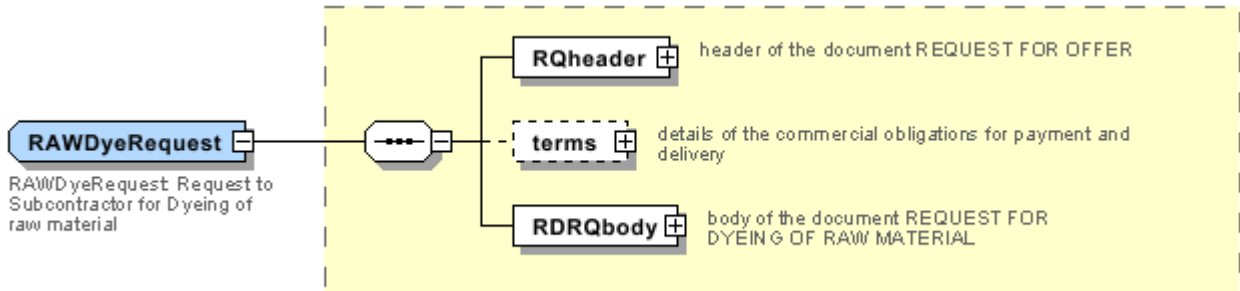

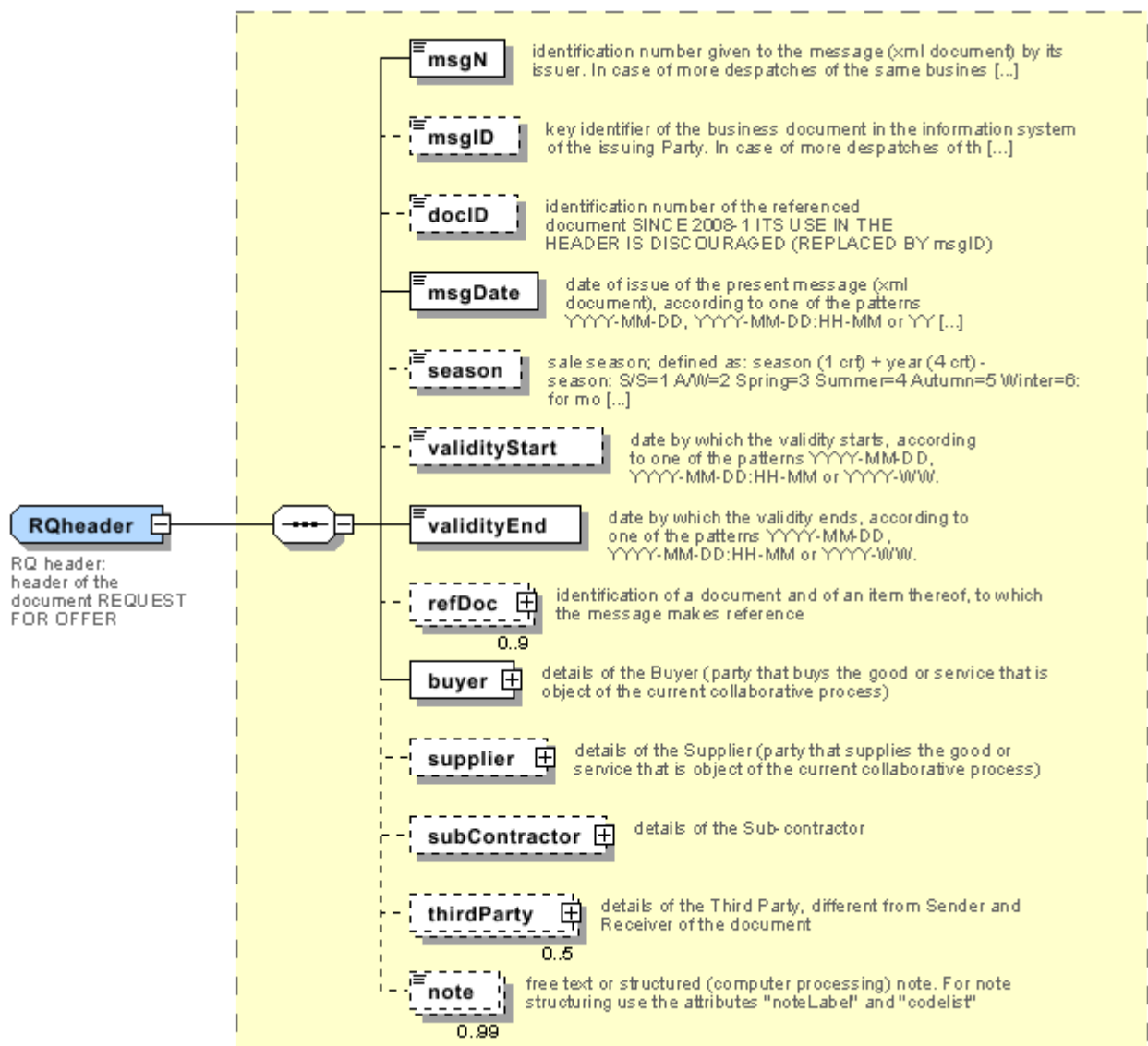
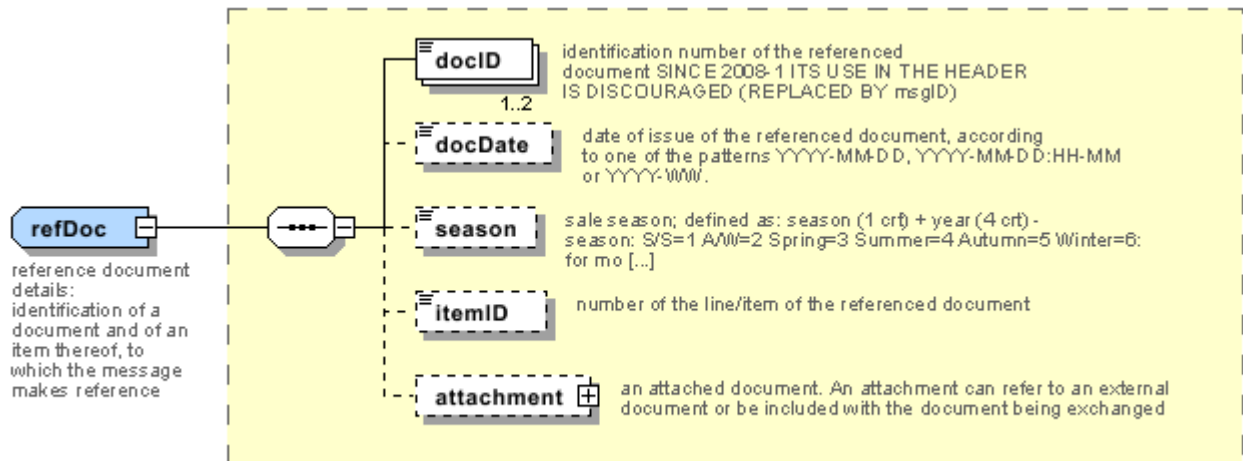

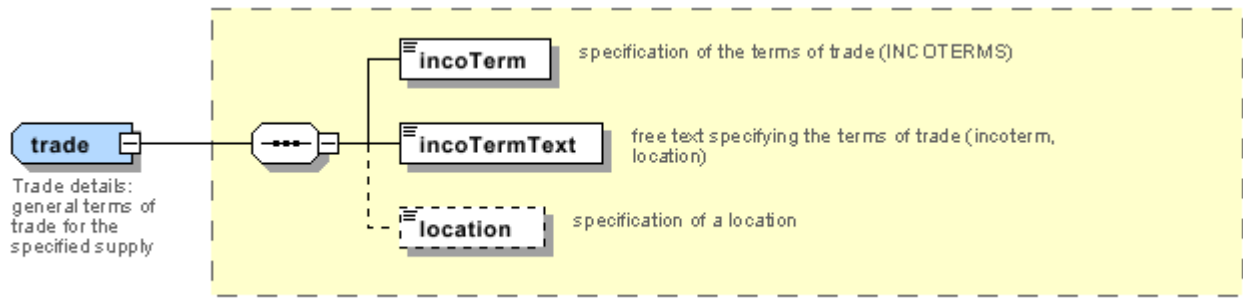



## Annex B

### NT100 - eBIZ TCFUpstream version

dictionary version

Agency name: eBIZ

tabella cod.: NT100

File codes list (Generic code): [http://www.ebiz.enea.it/moda-ml/repository/codelist/v2018-1/gc\\_NT100.xml](http://www.ebiz.enea.it/moda-ml/repository/codelist/v2018-1/gc_NT100.xml)

Code	Description	Adoption note	Version status	Date of insertion
2013-1	v2013-1			01/07/2013
2018-1	v2018-1		(N)	04/11/2018
draft	draft		(N)	08/09/2017

### NT11 - transport causal

reason for the transport

Agency name: eBIZ

tabella cod.: NT11

File codes list (Generic code): [http://www.ebiz.enea.it/moda-ml/repository/codelist/v2018-1/gc\\_NT11.xml](http://www.ebiz.enea.it/moda-ml/repository/codelist/v2018-1/gc_NT11.xml)

Code	Description	Adoption note	Version status	Date of insertion
FOC	free of charge			
FRW	return from re-works			
FST	return from storage			
FWW	return from view			
FWK	return from works			
IST	in storage			
NWK	return non-worked			
RJC	return from rejection			
SEL	to sell			
STO	to storage			
VEW	to view			
WRK	to works			

### NT12 - data source

party who has provided the data

Agency name: eBIZ

tabella cod.: NT12

File codes list (Generic code): [http://www.ebiz.enea.it/moda-ml/repository/codelist/v2018-1/gc\\_NT12.xml](http://www.ebiz.enea.it/moda-ml/repository/codelist/v2018-1/gc_NT12.xml)

Code	Description	Adoption note	Version status	Date of insertion
AC	internal test			
CO	external test			
CV	test after steaming			

### NT16 - VAT rate or code

VAT rate or code ( DEPRECATED, use dtScheme element )

tabella cod.: NT16

File codes list (Generic code): [http://www.ebiz.enea.it/moda-ml/repository/codelist/v2018-1/gc\\_NT16.xml](http://www.ebiz.enea.it/moda-ml/repository/codelist/v2018-1/gc_NT16.xml)

### NT18 - message function

function performed by the present message with regards to the transmission

Agency name: eBIZ

tabella cod.: NT18

File codes list (Generic code): [http://www.ebiz.enea.it/moda-ml/repository/codelist/v2018-1/gc\\_NT18.xml](http://www.ebiz.enea.it/moda-ml/repository/codelist/v2018-1/gc_NT18.xml)

Code	Description	Adoption note	Version status	Date of insertion
CA	delete this document			01/07/2013
CP	copy			
OR	original			
RC	re-transmission for data correction			
RT	re-transmission			

### NT2 - third party qualifier

Third Party role qualifier

Agency name: eBIZ



tabella cod.: NT2

File codes list (Generic code): [http://www.ebiz.enea.it/moda-ml/repository/codelist/v2018-1/gc\\_NT2.xml](http://www.ebiz.enea.it/moda-ml/repository/codelist/v2018-1/gc_NT2.xml)

Code	Description	Adoption note	Version status	Date of insertion
AG	Sales Agent			
AU	Auditor		(N)	08/04/2019
CE	Certification authority		(N)	08/04/2019
CO	Quality Controller			
DC	Response to			
DF	Invoicee			
DI	Copy to (CC)			28/10/2014
DM	Consignee			
DP	Consignment address (Delivery Party)			
IM	Importer			
OR	Originator			10/09/2014
SC	Sub contractor		(N)	10/04/2019
SM	Service/ePlatform manager		(N)	08/04/2019
SP	Forwarder			
TX	Tax Representative			

### NT29 - format of a date

format used for the date

Agency name: eBIZ

tabella cod.: NT29

File codes list (Generic code): [http://www.ebiz.enea.it/moda-ml/repository/codelist/v2018-1/gc\\_NT29.xml](http://www.ebiz.enea.it/moda-ml/repository/codelist/v2018-1/gc_NT29.xml)

Code	Description	Adoption note	Version status	Date of insertion
D	YYYY-MM-DD			
M	YYYY-MM-DD:HH-MM			
W	YYYY-WW			

### NT3 - data format

format of a string according to a customized User rule (local rule)

Agency name: eBIZ

tabella cod.: NT3

File codes list (Generic code): [http://www.ebiz.enea.it/moda-ml/repository/codelist/v2018-1/gc\\_NT3.xml](http://www.ebiz.enea.it/moda-ml/repository/codelist/v2018-1/gc_NT3.xml)

Code	Description	Adoption note	Version status	Date of insertion
EN4	GS1-GLN			01/07/2013
MD	mutually agreed			

### NT30 - raw material family

type of raw material with reference to the manufacturing process

Agency name: eBIZ

tabella cod.: NT30

File codes list (Generic code): [http://www.ebiz.enea.it/moda-ml/repository/codelist/v2018-1/gc\\_NT30.xml](http://www.ebiz.enea.it/moda-ml/repository/codelist/v2018-1/gc_NT30.xml)

Code	Description	Adoption note	Version status	Date of insertion
FIO	staple fibre			
TOP	top			
TOW	tow			

### NT6 - coding system owner/issuer

code specifying the organisation who has created or owns the coding or numbering system

Agency name: eBIZ

tabella cod.: NT6

File codes list (Generic code): [http://www.ebiz.enea.it/moda-ml/repository/codelist/v2018-1/gc\\_NT6.xml](http://www.ebiz.enea.it/moda-ml/repository/codelist/v2018-1/gc_NT6.xml)

Code	Description	Adoption note	Version status	Date of insertion
CL	Customer/buyer			
CO	Quality Controller			
EB	eBIZ	replaces 'ML'	(N)	18/03/2019
EN	GS1 ( ex-EAN International )			
ES	e-Stockflow			
FO	Supplier			
GS	GS1			01/07/2013
MF	VAT identifier		(U)	
ML	Moda-ML	DEPRECATED	(U)	

SP	Service Provider			
----	------------------	--	--	--

### NT7 - unit of measure (U)

specification of the unit of measure, it is a sub set of table Unit of Measure Code - UN/ECE REC 20 delivered by United Nations Economic Commission for Europe (UN/ECE)

Agency name: eBIZ / UN/ECE

tabella cod.: NT7

File codes list (Generic code): [http://www.ebiz.enea.it/moda-ml/repository/codelist/v2018-1/gc\\_NT7.xml](http://www.ebiz.enea.it/moda-ml/repository/codelist/v2018-1/gc_NT7.xml)

Other link: <http://docs.oasis-open.org/ubl/os-UBL-2.1/cl/gc/default/UnitOfMeasureCode-2.1.gc#>

Code	Description	Adoption note	Version status	Date of insertion
CMK	square centimetre		(N)	20/12/2017
CMQ	cubic centimetre		(N)	20/12/2017
CMT	centimetre			
CNE	centiNewton			
CO2TON	ton of CO2		(N)	10/09/2014
COUPLES	couples			
DMQ	cubic decimetre			
E37	pixel		(N)	11/04/2018
GRM	gram			
HUR	hour			
INH	inch			
KGM	kilogram			
KMT	kilometer			
KWH	kilowatthours		(N)	10/09/2014
LBR	pound			
MIN	minute			
MMK	square millimetre		(N)	20/12/2017
MTK	square metre		(N)	20/12/2017
MTQ	cubic metre			
MTR	metre			
NMB	numero			
ONZ	ounce			
P1	percent			
PPM	parts per milion			

PZ	piece		(U)	
RPM	rounds per metre			
YRD	yard			

### T1 - terms of payment

code specifying the terms or time by which the payment must be done

Agency name: eBIZ

tabella cod.: T1

File codes list (Generic code): [http://www.ebiz.enea.it/moda-ml/repository/codelist/v2018-1/gc\\_T1.xml](http://www.ebiz.enea.it/moda-ml/repository/codelist/v2018-1/gc_T1.xml)

Code	Description	Adoption note	Version status	Date of insertion
ANTICIP	PAYMENT IN ADVANCE			
BLCOLLECT/120D	BILL OF LADING 120 DD			
BLCOLLECT/30D	BILL OF LADING 30 DD			
BLCOLLECT/60D	BILL OF LADING 60 DD			
BLCOLLECT/90D	BILL OF LADING 90 DD			
CASH	PAYMENT ON DELIVERY			
CASHINV	PAYMENT ON RECEIPT OF INVOICE			
CREDOC/0D	DOCUMENTARY CREDIT FOR PAYM. AT SIGHT			
CREDOC/120	DOCUMENTARY CREDIT FOR PAYM. AT 120 DD			
CREDOC/150	DOCUMENTARY CREDIT FOR PAYM. AT 150 DD			
CREDOC/180	DOCUMENTARY CREDIT FOR PAYM. AT 180 DD			
CREDOC/30D	DOCUMENTARY CREDIT FOR PAYM. AT 30 DD			
CREDOC/45D	DOCUMENTARY CREDIT FOR PAYM. AT 45 DD			
CREDOC/60	DOCUMENTARY CREDIT FOR PAYM. AT 60 DD			
CREDOC/90	DOCUMENTARY CREDIT FOR PAYM. AT 90 DD			
DEL/10	PAYMENT AT 10 DD AFTER DELIVERY			
DOCOLLECT/120D	DOCUMENTARY COLLECTION AT 120 DD			
DOCOLLECT/30D	DOCUMENTARY COLLECTION AT 30 DD			
DOCOLLECT/60D	DOCUMENTARY COLLECTION AT 60 DD			
DOCOLLECT/90D	DOCUMENTARY COLLECTION AT 90 DD			

INV/120D	PAYMENT AT 120 DD AFTER RECEIPT OF INVOICE			
INV/150D	PAYMENT AT 150 DD AFTER RECEIPT OF INVOICE			
INV/180D	PAYMENT AT 180 DD AFTER RECEIPT OF INVOICE			
INV/30D	PAYMENT AT 30 DD AFTER RECEIPT OF INVOICE			
INV/45D	PAYMENT AT 45 DD AFTER RECEIPT OF INVOICE			
INV/60D	PAYMENT AT 60 DD AFTER RECEIPT OF INVOICE			
INV/90D	PAYMENT AT 90 DD AFTER RECEIPT OF INVOICE			
INVULTIMO	PAYMENT AT END MONTH RECEIPT INVOICE			
INVULTIMO/10D	PAYMENT 10 DD AFTER END MONTH RECEIPT INVOICE			
INVULTIMO/120D	PAYMENT 120 DD AFTER END MONTH RECEIPT INVOICE			
INVULTIMO/150D	PAYMENT 150 DD AFTER END MONTH RECEIPT INVOICE			
INVULTIMO/180D	PAYMENT 180 DD AFTER END MONTH RECEIPT INVOICE			
INVULTIMO/240D	PAYMENT 240 DD AFTER END MONTH RECEIPT INVOICE			
INVULTIMO/30D	PAYMENT 30 DD AFTER END MONTH RECEIPT INVOICE			
INVULTIMO/45D	PAYMENT 45 DD AFTER END MONTH RECEIPT INVOICE			
INVULTIMO/60D	PAYMENT 60 DD AFTER END MONTH RECEIPT INVOICE			
INVULTIMO/90D	PAYMENT 90 DD AFTER END MONTH RECEIPT INVOICE			
NOPAY	WITHOUT PAYMENT			
RECREDOC/0D	IRREVOC. DOCUMENTARY CREDIT FOR PAYM. AT SIGHT			
RECREDOC/120D	IRREVOC. DOCUMENTARY CREDIT FOR PAYM. AT 120 DD			
RECREDOC/150D	IRREVOC. DOCUMENTARY CREDIT FOR PAYM. AT 150 DD			
RECREDOC/180D	IRREVOC. DOCUMENTARY CREDIT FOR PAYM. AT 180 DD			
RECREDOC/30D	IRREVOC. DOCUMENTARY CREDIT FOR PAYM. AT 30 DD			
RECREDOC/45D	IRREVOC. DOCUMENTARY CREDIT FOR PAYM. AT 45 DD			
RECREDOC/60D	IRREVOC. DOCUMENTARY CREDIT FOR PAYM. AT 60 DD			

RECREDOC/90D	IRREVOC. DOCUMENTARY CREDIT FOR PAYM. AT 90 DD			
ULTIMO	PAYMENT BY END MONTH OF DELIVERY			
ULTIMO/10	PAYMENT AT 10 DD AFTER END MONTH OF DELIVERY			

### T10 - ISO3166 - Country

code of the nation

Agency name: ISO

tabella cod.: T10

File codes list (Generic code): [http://www.ebiz.enea.it/moda-ml/repository/codelist/v2018-1/gc\\_T10.xml](http://www.ebiz.enea.it/moda-ml/repository/codelist/v2018-1/gc_T10.xml)

Table not printed: there are 239 elements, more than the maximum specified for printing: 99.

### T2 - Modes of payment

way or means of payment

Agency name: eBIZ

tabella cod.: T2

File codes list (Generic code): [http://www.ebiz.enea.it/moda-ml/repository/codelist/v2018-1/gc\\_T2.xml](http://www.ebiz.enea.it/moda-ml/repository/codelist/v2018-1/gc_T2.xml)

Code	Description	Adoption note	Version status	Date of insertion
BB	bank transfer			
IA	collection through Agent			
IS	collection through Forwarder			
RB	bank receipt			
RD	remittance			
SW	bank SWIFT			
TR	bank draft			

### T200 - type of job on raw material

operation of a work cycle for raw material

Agency name: eBIZ

tabella cod.: T200

File codes list (Generic code): [http://www.ebiz.enea.it/moda-ml/repository/codelist/v2018-1/gc\\_T200.xml](http://www.ebiz.enea.it/moda-ml/repository/codelist/v2018-1/gc_T200.xml)

Code	Description	Adoption note	Version status	Date of insertion
01	dejarrare			
02	to wash			
03	to dry			
04	to mix			
05	to comb			
06	to cut			
07	to tear open			
08	to beat			
09	to carbonise			
10	to dye			
11	felting			
12	to smoothen			
13	vigoreux			
14	angra			
15	basolan			
16	unshrinkable			
17	to blend			

## T21 - type of document

type or class to which the referenced document belongs

Agency name: eBIZ

tabella cod.: T21

File codes list (Generic code): [http://www.ebiz.enea.it/moda-ml/repository/codelist/v2018-1/gc\\_T21.xml](http://www.ebiz.enea.it/moda-ml/repository/codelist/v2018-1/gc_T21.xml)

Code	Description	Adoption note	Version status	Date of insertion
BOR	blanket order		(N)	01/02/2018
CAT	Price catalogue - tech sheet			
CEO	Certificate of origin		(N)	13/04/2018
CER	Certificate		(N)	13/04/2018
COC	colour card			
CRN	Credit note			08/09/2017
CTO	Checking order			01/07/2013
CTR	Contract		(U)	

CXF	CxF3 file			01/07/2013
DAD	Darn order			
DDT	ddt			
DEA	Despatch advise			
DER	Despatch request			
DR	Document Request			02/12/2014
FOR	Forecast			02/12/2014
GSO	Garment stock offer			
GSX	Garment stock offer change			
INV	Invoice			
KCC	Knitting-Clothing Commission Order			02/12/2014
KCI	Garment in Work Inventory Report			02/12/2014
M2M	Made to Measure Production Order			02/12/2014
MAS	Master marker			
MCI	Visual merchandising instruction		(N)	13/04/2018
OCH	Order change			
OFF	Offer			
ORD	Purchase order			
ORP	Order response			
OSR	order status request			
OSS	Offer status			02/12/2014
OST	Order status			
OUR	our reference			
QR	Quality Report			02/12/2014
RAI	Raw Material in Work Inventory Report			02/12/2014
RDC	Raw dyeing commission order			
RDH	Raw dyeing order change			
RDR	Raw dyeing order response			
REA	Receiving advise			
REQ	Request for Offer			
RET	Return			02/12/2014
RSC	Spinning commission order			
RSH	Spinning order change			
RSR	Spinning order response			
SCL	process sheet			



TFC	Textile dyeing-finishing commission order			
TFX	Textile Dyeing-Finishing Order Change			02/12/2014
TPC	Textile printing commission order			
TPX	Textile Printing Order Change			02/12/2014
TWI	Textile in work inventory			
VMI	visual merchandising instructions		(N)	01/02/2018
WAC	Warping commission order			
WEC	Weaving commission order			
YDC	Yarn dyeing commission order			
YDH	Yarn dyeing order change			
YDR	Yarn dyeing order response			
YTC	Twisting commission order			
YWI	Yarn in work inventory			

### T22 - raw material characteristics type

physical or mechanical parameter used to define a characteristics of a raw material

Agency name: eBIZ

tabella cod.: T22

File codes list (Generic code): [http://www.ebiz.enea.it/moda-ml/repository/codelist/v2018-1/gc\\_T22.xml](http://www.ebiz.enea.it/moda-ml/repository/codelist/v2018-1/gc_T22.xml)

Code	Description	Adoption note	Version status	Date of insertion
FIN	fineness			
LNG	length			
RTR	shrinkage			
YLD	yeld			

### T3 - terms of delivery

specification of the terms of trade (INCOTERMS)

Agency name: Incoterms

tabella cod.: T3

File codes list (Generic code): [http://www.ebiz.enea.it/moda-ml/repository/codelist/v2018-1/gc\\_T3.xml](http://www.ebiz.enea.it/moda-ml/repository/codelist/v2018-1/gc_T3.xml)

Cod e	Description	Adoption note	Versi on statu s	Date of insertio n
-------	-------------	---------------	------------------	--------------------

CFR	COST AND FREIGHT (named port of destination)			
CIF	COST, INSURANCE AND FREIGHT (named port of destination)			
CIP	CARRIAGE AND INSURANCE PAID (named place of destination)			
CP	CARRIAGE PAID (named place of destination)			
DAF	DELIVERED AT FRONTIER (named place)	according to Incoterms® 2010 it is obsolete		08/12/2017
DAP	Delivered at Place of destination (named place of destination)	according to Incoterms® 2010		08/12/2017
DAT	Delivered at Terminal (named place of destination)	according to Incoterms® 2010		08/12/2017
DDP	DELIVERED DUTY PAID (named place of destination)			
DDU	DELIVERED DUTY UNPAID (named place of destination)	according to Incoterms® 2010 it is obsolete, use DAP		08/12/2017
DEQ	DELIVERED EX-QUAY (named port of destination)	according to Incoterms® 2010 it is obsolete		08/12/2017
DES	DELIVERED EX-SHIP (named port of destination)	according to Incoterms® 2010 it is obsolete		08/12/2017
EXW	EX WORKS (named place)			
FAS	FREE ALONGSIDE SHIP (named port of shipment)			
FC	FREE CARRIER (named place)			
FOB	FREE ON BOARD (named port of shipment)			

### T38 - transport conditions

special condition of transport or special service requested to the Forwarder

tabella cod.: T38

File codes list (Generic code): [http://www.ebiz.enea.it/moda-ml/repository/codelist/v2018-1/gc\\_T38.xml](http://www.ebiz.enea.it/moda-ml/repository/codelist/v2018-1/gc_T38.xml)

Code	Description	Adoption note	Version status	Date of insertion
ACC	arrange customs clearance			
CAL	Carrier loads			
CAU	Carrier unloads			
CMR	CMR carnet			

FFN	freight forwarders national conditions			
FLD	special agreement for full loading			
NCC	do not arrange customs clearance			
PPB	packaging paid by Buyer			
PPS	packaging paid by Supplier			
PRO	proof of delivery			
RFR	return container free			
RPC	return container paid by Customer			
RPS	return container paid by Supplier			
SHL	Shipper loads			
SHU	Consignee unloads			

#### T40 - type of transport means

means of transport, in general or referred to a specific leg

Agency name: eBIZ

tabella cod.: T40

File codes list (Generic code): [http://www.ebiz.enea.it/moda-ml/repository/codelist/v2018-1/gc\\_T40.xml](http://www.ebiz.enea.it/moda-ml/repository/codelist/v2018-1/gc_T40.xml)

Code	Description	Adoption note	Version status	Date of insertion
AIR	aircraft			
SHP	ship			
TRU	truck			
VAN	van			

#### T41 - type of Allowance or Charge

coded specification of an Allowance or Charge (elaborated from UNECE 4465)

Agency name: eBIZ

tabella cod.: T41

File codes list (Generic code): [http://www.ebiz.enea.it/moda-ml/repository/codelist/v2018-1/gc\\_T41.xml](http://www.ebiz.enea.it/moda-ml/repository/codelist/v2018-1/gc_T41.xml)

Code	Description	Adoption note	Version status	Date of insertion
1	Agreed settlement		(N)	19/08/2018

10	Costs for draft		(N)	19/08/2018
11	Bank charges	DEPRECATED, use CBK	(N)	19/08/2018
12	Agent commission		(N)	19/08/2018
14	Wrong delivery		(N)	19/08/2018
15	Goods returned to agent		(N)	19/08/2018
16	Goods partly returned		(N)	19/08/2018
17	Transport damage		(N)	19/08/2018
19	Trade discount		(N)	19/08/2018
2	Below specification goods		(N)	19/08/2018
20	Deduction for late delivery	DEPRECATED, use CWB	(N)	19/08/2018
21	Advertising costs		(N)	19/08/2018
22	Customs duties		(N)	19/08/2018
23	Telephone and postal costs		(N)	19/08/2018
24	Repair costs		(N)	19/08/2018
25	Attorney fees		(N)	19/08/2018
26	Taxes		(N)	19/08/2018
3	Damaged goods		(N)	19/08/2018
30	Direct payment to seller		(N)	19/08/2018
32	Goods not delivered		(N)	19/08/2018
33	Late delivery		(N)	19/08/2018
35	Goods returned		(N)	19/08/2018
36	Invoice not received		(N)	19/08/2018

37	Credit note to debtor/not to us		(N)	19/08/2018
38	Deducted bonus		(N)	19/08/2018
39	Deducted discount		(N)	19/08/2018
4	Short delivery		(N)	19/08/2018
40	Deducted freight costs		(N)	19/08/2018
41	Deduction against other invoices		(N)	19/08/2018
42	Credit balance(s)		(N)	19/08/2018
45	Debit note to seller		(N)	19/08/2018
46	Discount beyond terms		(N)	19/08/2018
48	Allowance/charge error		(N)	19/08/2018
49	Substitute product		(N)	19/08/2018
50	Terms of sale error		(N)	19/08/2018
52	Wrong invoice		(N)	19/08/2018
53	Duplicate invoice		(N)	19/08/2018
54	Weight error		(N)	19/08/2018
55	Additional charge not authorized		(N)	19/08/2018
56	Incorrect discount		(N)	19/08/2018
57	Price change		(N)	19/08/2018
58	Variation		(N)	19/08/2018
59	Chargeback		(N)	19/08/2018
65	Settlement to agent		(N)	19/08/2018
66	Cash discount		(N)	19/08/2018

7	Payment on account		(N)	19/08/2018
70	Wrong monetary amount resulting from incorrect free goods quantity		(N)	19/08/2018
72	Temporary special promotion		(N)	19/08/2018
73	Difference in tax rate		(N)	19/08/2018
74	Quantity discount		(N)	19/08/2018
75	Promotion discount		(N)	19/08/2018
76	Cancellation deadline passed		(N)	19/08/2018
77	Pricing discount		(N)	19/08/2018
78	Volume discount		(N)	19/08/2018
79	Sundry discount		(N)	19/08/2018
8	Returnable container charge included		(N)	19/08/2018
9	Invoice error		(N)	19/08/2018
AWA	bonus for works ahead of schedule			
CBK	bank charges			
CCR	servizio di corriere			
CIN	insurance			
CLB	labelling			
CPK	packing			
CSP	special packing			
CWB	penalty for works behind schedule			

### T61 - duty or tax or fee type

duty or tax or fee type

Agency name: eBIZ

tabella cod.: T61

File codes list (Generic code): [http://www.ebiz.enea.it/moda-ml/repository/codelist/v2018-1/gc\\_T61.xml](http://www.ebiz.enea.it/moda-ml/repository/codelist/v2018-1/gc_T61.xml)

Code	Description	Adoption note	Version status	Date of insertion
BOL	stamp duty			01/07/2013
CUD	customs duty			01/07/2013
ENV	environmental tax			01/07/2013
FRE	no tax			01/07/2013
OTH	other tax charges			01/07/2013
VAT	value added tax			01/07/2013

### T62 - duty or tax or fee category

duty or tax or fee category

Agency name: eBIZ

tabella cod.: T62

File codes list (Generic code): [http://www.ebiz.enea.it/moda-ml/repository/codelist/v2018-1/gc\\_T62.xml](http://www.ebiz.enea.it/moda-ml/repository/codelist/v2018-1/gc_T62.xml)

Code	Description	Adoption note	Version status	Date of insertion
AA	lower than standard rate			01/07/2013
E	tax not applicable			01/07/2013
H	higher than standard rate			01/07/2013
O	outside scope of tax			01/07/2013
S	standard rate			01/07/2013
Z	zero rate goods			01/07/2013

### T8 - Modes of Transport

way of transport, in general or referred to the specified leg

Agency name: eBIZ

tabella cod.: T8

File codes list (Generic code): [http://www.ebiz.enea.it/moda-ml/repository/codelist/v2018-1/gc\\_T8.xml](http://www.ebiz.enea.it/moda-ml/repository/codelist/v2018-1/gc_T8.xml)

Code	Description	Adoption note	Version status	Date of insertion
1	MARITIME TRANSPORT			
10	Courier			01/07/2013

2	RAIL TRANSPORT			
3	ROAD TRANSPORT			
4	AIR TRANSPORT			
5	MAIL			
6	AIR + SHIP TRANSPORT			
8	INLAND WATER TRANSPORT			
9	MODE UNKNOWN			

### T9 - ISO4217 - Currency

currency code

Agency name: ISO

tabella cod.: T9

File codes list (Generic code): [http://www.ebiz.enea.it/moda-ml/repository/codelist/v2018-1/gc\\_T9.xml](http://www.ebiz.enea.it/moda-ml/repository/codelist/v2018-1/gc_T9.xml)

Table not printed: there are 205 elements, more than the maximum specified for printing: 99.



## Annex C

### New or changed elements towards previous version

Changes or added elements (changes in description excluded; changes in aggregation notes and best practice included): 90

Test Type	Tag	Status	Item type	Changes related to
Attrib	AC_amount	NEW	AC amount	Has NEW attribute: data currency
Element(E)	AC_categoryText	UPDATED	AC category text	Property: Length_Max Old value: 70 New value: 250
Attrib	additionalIdentifier	NEW	Additional Party Identifier	Has NEW attribute: numbering organisation code
Attrib	additionalIdentifier	NEW	Additional Party Identifier	Has NEW attribute: id Qualifier
Element(I)	additionalIdentifier	NEW	Additional Party Identifier	
Attrib	allowanceCharge	NEW	Allowance and Charge	Has NEW attribute: is Charge
Attrib	allowanceCharge	NEW	Allowance and Charge	Has NEW attribute: maximum quantity
Attrib	allowanceCharge	NEW	Allowance and Charge	Has NEW attribute: minimum quantity
Attrib	allowanceCharge	NEW	Allowance and Charge	Has NEW attribute: data currency
Attrib	allowanceCharge	NEW	Allowance and Charge	Has NEW attribute: unit of measure code
Element(I)	attachment	NEW	attachment	
Child	attachment	NEW	attachment	Has NEW child of: file name
Child	attachment	NEW	attachment	Has NEW child of: external reference
Child	attachment	NEW	attachment	Has NEW child of: binary object
Attrib	binaryObject	NEW	binary object	Has NEW attribute: encoding

Attrib	binary Object	NEW	binary object	Has NEW attribute: mime
Attrib	binary Object	NEW	binary object	Has NEW attribute: format
Attrib	binary Object	NEW	binary object	Has NEW attribute: character set
Element(l)	binary Object	NEW	binary object	
Child	buyer	NEW	Buyer (*)	Has NEW child of: Party identifier
Child	buyer	NEW	Buyer (*)	Has NEW child of: Additional Party Identifier
Attrib	buyer	NEW	Buyer (*)	Has NEW attribute: sender Party qualifier
Element(l)	characterSetCode	NEW	character set code	
Element(l)	characterSet	NEW	character set	
Element(E)	delivery Place	UPDATED	delivery place	Property: Length_Max Old value: 40 New value: 250
Attrib	despatchDate	NEW	despatch date	Has NEW attribute: date format
Element(l)	despatchDate	NEW	despatch date	
Element(l)	despatchPlace	NEW	despatch place	
Element(E)	email	UPDATED	e-mail	Property: Length_Max Old value: 80 New value: 250
Element(l)	encodingCode	NEW	encoding code	
Element(l)	encoding	NEW	encoding	
Child	externalReference	NEW	external reference	Has NEW child of: uri
Child	externalReference	NEW	external reference	Has NEW child of: format code
Child	externalReference	NEW	external reference	Has NEW child of: character set code

Child	externalReference	NEW	external reference	Has NEW child of: mime code
Child	externalReference	NEW	external reference	Has NEW child of: encoding code
Element(l)	externalReference	NEW	external reference	
Attribute	fileName	NEW	file name	Has NEW attribute: numbering organisation code
Element(l)	fileName	NEW	file name	
Element(l)	formatCode	NEW	format code	
Element(l)	format	NEW	format	
Attribute	note	UPDATED	general note	Its attribute: numbering organisation code  Property: Aggregation Note_English Old value: New value: <i>must be used to specify the organization that created the list of codes used in "noteLabel"</i>
Element(l)	idQualifier	NEW	id Qualifier	
Element(l)	isCharge	NEW	is Charge	
Element(l)	isURL	NEW	is URL	
Element(E)	legalName	UPDATED	Legal name	Property: Length_Max Old value: 80 New value: 250
Element(E)	itemID	UPDATED	line item number	Property: Length_Max Old value: 6 New value: 40
Attribute	lineN	UPDATED	line number	Its attribute: VAT rate  Property: Aggregation Note_English Old value: New value: <i>Deprecated, prefer dtScheme when available.</i>
Element(l)	maxQty	NEW	maximum quantity	
Element(l)	mimeCode	NEW	mime code	
Element(l)	mime	NEW	mime	

Element(l)	progr	NEW	progressive number	
Child	rawMnrOperation	UPDATE	raw manufacturing operation	relationship with child: reference document details  Property: Cardmax Old value: 1 New value: 9
Child	rawMnrOperation	UPDATE	raw manufacturing operation	relationship with child: general note  Property: Cardmax Old value: 19 New value: 99
Element(e)	rawCharacterText	UPDATE	raw material characteristics text	Property: Length_Max Old value: 40 New value: 250
Child	RDRQitem	UPDATE	RDRQ item	relationship with child: Third Party  Property: Cardmax Old value: 1 New value: 3
Child	RDRQitem	UPDATE	RDRQ item	relationship with child: product quantity  Property: BestPractice_English Old value: New value: <i>this element can have two instances only if the units of measure are different</i>
Child	RDRQitem	UPDATE	RDRQ item	relationship with child: general note  Property: Cardmax Old value: 19 New value: 99
Child	refDoc	NEW	reference document details	Has NEW child of: attachment
Child	refDoc	UPDATE	reference document details	relationship with child: document identifier  Property: BestPractice_English Old value: New value: <i>numberingOrg indicates the role that produced the document identifier (it is allowed to declare two different ones -e.g. customer and supplier - with two docID with different numberingOrg)</i>
Child	RQheader	NEW	RQ header	Has NEW child of: Third Party
Child	RQheader	UPDATE	RQ header	relationship with child: general note  Property: Cardmax

				Old value: 19 New value: 99
Attrib	season	NEW	season identifier	Has NEW attribute: code list reference
Attrib	season	NEW	season identifier	Has NEW attribute: numbering organisation code
Attrib	season	NEW	season identifier	Has NEW attribute: code list name
Attrib	season	NEW	season identifier	Has NEW attribute: code list version
Child	subContractor	NEW	Sub-contractor (*)	Has NEW child of: Party identifier
Attrib	subContractor	NEW	Sub-contractor (*)	Has NEW attribute: sender Party qualifier
Element(l)	subDepartment	NEW	department identifier	
Child	supplier	NEW	Supplier (*)	Has NEW child of: Party identifier
Child	supplier	NEW	Supplier (*)	Has NEW child of: Additional Party Identifier
Attrib	supplier	NEW	Supplier (*)	Has NEW attribute: sender Party qualifier
Attrib	legalRef	NEW	tax legal reference	Has NEW attribute: code list name
Attrib	legalRef	NEW	tax legal reference	Has NEW attribute: numbering organisation code
Attrib	legalRef	NEW	tax legal reference	Has NEW attribute: code list version
Attrib	legalRef	UPDATED	tax legal reference	Its attribute: code list reference  Property: Use Old value: <i>Required</i> New value: <i>Optional</i>
Child	dtScheme	UPDATED	tax scheme	relationship with child: general note  Property: Cardmax Old value: 19 New value: 99
Element(E)	payTermText	UPDATED	terms of payment text	Property: Length_Max Old value: 40 New value: 250
Element(E)	incotermsText	UPDATED	terms of trade text	Property: Length_Max Old value: 70 New value: 250

Element(E)	method	UPDATE	test method identifier	Property: Length_Max Old value: 25 New value: 80
Child	thirdParty	NEW	Third Party (*)	Has NEW child of: Party identifier
Attribute	thirdParty	NEW	Third Party (*)	Has NEW attribute: sender Party qualifier
Child	terms	UPDATE	Trade conditions	relationship with child: Transport information  Property: Cardmax Old value: 1 New value: 5
Element(E)	transportConditionText	UPDATE	transport condition - text	Property: Length_Max Old value: 100 New value: 250
Child	transportInfo	NEW	Transport information	Has NEW child of: despatch place
Child	transportInfo	NEW	Transport information	Has NEW child of: despatch date
Child	transportInfo	NEW	Transport information	Has NEW child of: effective delivery date
Attribute	transportInfo	NEW	Transport information	Has NEW attribute: progressive number
Attribute	uri	NEW	uri	Has NEW attribute: is URL
Element(I)	uri	NEW	uri	

## Annex D

### New or changed tables and codes towards previous version

Changes or added items (changes in CodeListAgencyName excluded; changes in adoption notes and code description included): 83

Test Type	Status	Table code	Table description	Code	Change description
Table	UPDATE	NT 100	eBIZ TCFUpstream version		Description_English Old value: <i>eBIZ Moda-ML version</i> New value: <i>eBIZ TCFUpstream version</i>
Code	NEW	NT 100		2018-1 (v2018-1)	
Code	NEW	NT 100		draft (draft)	
Table	UPDATE	NT 16	VAT rate or code		Generalities Old value: <i>VAT rate or code ( deprecated, use dtScheme element )</i> New value: <i>VAT rate or code ( DEPRECA TED, use dtScheme element )</i>
Code	NEW	NT 2		AU (Auditor)	
Code	NEW	NT 2		CE (Certification authority)	
Code	NEW	NT 2		SC (Sub contractor)	
Code	NEW	NT 2		SM (Service/ePlatform manager)	
Code	NEW	NT 6		EB (eBIZ)	
Code	UPDATE	NT 6		ML (DEPRECATED)	adoption_note Old value: New value: <i>DEPRECATED</i>
Code	NEW	NT 7		CMK (square centimetre)	
Code	NEW	NT 7		CMQ (cubic centimetre)	
Code	NEW	NT 7		E37 (pixel)	
Code	NEW	NT 7		KWH (kilowatthours)	
Code	NEW	NT 7		MMK (square millimetre)	

Code	NEW	NT7		<i>MTK</i> (square metre)	
Code	NEW	NT7		<i>CO2TON</i> (ton of CO2)	
Table	UPDATED	NT7	unit of measure		OtherExternalReferenceURL Old value: New value: <a href="http://docs.oasis-open.org/ubl/os-UBL-2.1/cl/gc/default/UnitOfMeasureCode-2.1.gc#">#http://docs.oasis-open.org/ubl/os-UBL-2.1/cl/gc/default/UnitOfMeasureCode-2.1.gc#</a>
Table	UPDATED	NT7	unit of measure		Description_English Old value: <i>unity of measure</i> New value: <i>unit of measure</i>
Code	NEW	T21		<i>BOR</i> (blanket order)	
Code	NEW	T21		<i>CEO</i> (Certificate of origin)	
Code	NEW	T21		<i>CER</i> (Certificate)	
Code	UPDATED	T21		<i>CTR</i> (Contract)	Text_English Old value: <i>contract</i> New value: <i>Contract</i>
Code	NEW	T21		<i>MCI</i> (Visual merchandising instruction)	
Code	NEW	T21		<i>VMI</i> (visual merchandising instructions)	
Code	NEW	T41		<i>1</i> (Agreed settlement)	
Code	NEW	T41		<i>2</i> (Below specification goods)	
Code	NEW	T41		<i>3</i> (Damaged goods)	
Code	NEW	T41		<i>4</i> (Short delivery)	
Code	NEW	T41		<i>7</i> (Payment on account)	
Code	NEW	T41		<i>8</i> (Returnable container charge included)	
Code	NEW	T41		<i>9</i> (Invoice error)	
Code	NEW	T41		<i>10</i> (Costs for draft)	
Code	NEW	T41		<i>11</i> (Bank charges)	



Co de	NEW	T4 1		12 (Agent commission)	
Co de	NEW	T4 1		14 (Wrong delivery)	
Co de	NEW	T4 1		15 (Goods returned to agent)	
Co de	NEW	T4 1		16 (Goods partly returned)	
Co de	NEW	T4 1		17 (Transport damage)	
Co de	NEW	T4 1		19 (Trade discount)	
Co de	NEW	T4 1		20 (Deduction for late delivery)	
Co de	NEW	T4 1		21 (Advertising costs)	
Co de	NEW	T4 1		22 (Customs duties)	
Co de	NEW	T4 1		23 (Telephone and postal costs)	
Co de	NEW	T4 1		24 (Repair costs)	
Co de	NEW	T4 1		25 (Attorney fees)	
Co de	NEW	T4 1		26 (Taxes)	
Co de	NEW	T4 1		30 (Direct payment to seller)	
Co de	NEW	T4 1		32 (Goods not delivered)	
Co de	NEW	T4 1		33 (Late delivery)	
Co de	NEW	T4 1		35 (Goods returned)	
Co de	NEW	T4 1		36 (Invoice not received)	
Co de	NEW	T4 1		37 (Credit note to debtor/not to us )	
Co de	NEW	T4 1		38 (Deducted bonus)	
Co de	NEW	T4 1		39 (Deducted discount)	
Co de	NEW	T4 1		40 (Deducted freight costs)	

Co de	NEW	T4 1		41 (Deduction against other invoices)	
Co de	NEW	T4 1		42 (Credit balance(s))	
Co de	NEW	T4 1		45 (Debit note to seller)	
Co de	NEW	T4 1		46 (Discount beyond terms)	
Co de	NEW	T4 1		48 (Allowance/charge error)	
Co de	NEW	T4 1		49 (Substitute product)	
Co de	NEW	T4 1		50 (Terms of sale error)	
Co de	NEW	T4 1		52 (Wrong invoice)	
Co de	NEW	T4 1		53 (Duplicate invoice)	
Co de	NEW	T4 1		54 (Weight error)	
Co de	NEW	T4 1		55 (Additional charge not authorized)	
Co de	NEW	T4 1		56 (Incorrect discount)	
Co de	NEW	T4 1		57 (Price change)	
Co de	NEW	T4 1		58 (Variation)	
Co de	NEW	T4 1		59 (Chargeback)	
Co de	NEW	T4 1		65 (Settlement to agent)	
Co de	NEW	T4 1		66 (Cash discount)	
Co de	NEW	T4 1		70 (Wrong monetary amount resulting from incorrect free goods quantity)	
Co de	NEW	T4 1		72 (Temporary special promotion)	
Co de	NEW	T4 1		73 (Difference in tax rate)	
Co de	NEW	T4 1		74 (Quantity discount)	

Code	NEW	T4 1		75 (Promotion discount)	
Code	NEW	T4 1		76 (Cancellation deadline passed )	
Code	NEW	T4 1		77 (Pricing discount)	
Code	NEW	T4 1		78 (Volume discount)	
Code	NEW	T4 1		79 (Sundry discount)	
Table	UPD ATE D	T4 1	type of Allowance or Charge		Generalities Old value: <i>coded specification of an Allowance or Charge</i> New value: <i>coded specification of an Allowance or Charge (elaborated from UNECE 4465)</i>